

Scientific American

A WEEKLY JOURNAL OF PRACTICAL INFORMATION IN ART, SCIENCE, MECHANICS, CHEMISTRY AND MANUFACTURES.

VOL. VIII.—NO. 2. }
(NEW SERIES.)

NEW YORK, JANUARY 10, 1863.

{ SINGLE COPIES SIX CENTS.
{ \$3 PER ANNUM—IN ADVANCE.

Improved Saw Bench.

Much inconvenience is felt by wood-workers, who do not employ steam or water power on their premises, in re-sawing heavy planks and timber; it is a work occupying much time and involving great labor. To remedy this difficulty, Mr. J. A. Talpey has invented the machine which is represented in our engraving. It consists of a short wooden bench, A, having bearings upon each side, in which runs the usual arbor provided with the saw, B; behind the saw, a small roller, a, is let into the bench, which facilitates feeding the stuff. The transverse shaft, C, has a small toothed wheel, b, fixed in its center, which catches in the lumber as it is presented to the saw and draws it in; the shaft being driven, during this operation, by the rag wheel, D, and another upon a shaft which is invisible. The cone pulleys, E and E', drive the circular saw through the medium of the belt, e, the upper one, E, being attached to the slotted frame, f. This frame regulates the height of the feed shaft and allows it to be elevated or depressed for any thickness of stuff; it is secured in place by the thumb-screws, g. It will also be seen, by glancing at the engraving, that the operation of feeding the stuff is materially aided by the position in which it is offered to the saw, that is, from behind; the teeth revolving from the workman instead of toward him, as is usually the case. The operation of this self-feeding saw is very simple, involving no other labor than that required to turn the handle of the fly-wheel, and to place the board to be cut in position; the toothed roller then takes the operation in charge, and, by means of the ordinary guide, h, at one side, cuts to a straight line. The inventor states that a two-inch oak plank can be sawed without difficulty on this machine; it seems very convenient, and we do not doubt it will be found useful in a great many shops.

Patented July 1, 1862, by Mr. J. A. Talpey, of Somerville, Mass. Further particulars can be obtained from him.

Are Angulated Armor Plates of any Use?

The London *Mechanics' Magazine* states that no particular benefit can be derived from angulated armor plates that cannot be secured with the same weight of metal in vertical plates. Experiments were recently made at Shoeburyness, with plates set at an angle of 45 degrees, in a target, and they were

pierced with flat-fronted steel shot. In no case was any of such shot deflected by the metal being at an angle. The effect of the incline is simply to increase the horizontal thickness to be penetrated by shot, and the increase is in proportion to the angle of inclination. But as more plates are required in a vessel with angulated than vertical sides, if this extra weight of metal be given in thickness to vertical plates, the same amount of resistance to shot is ob-

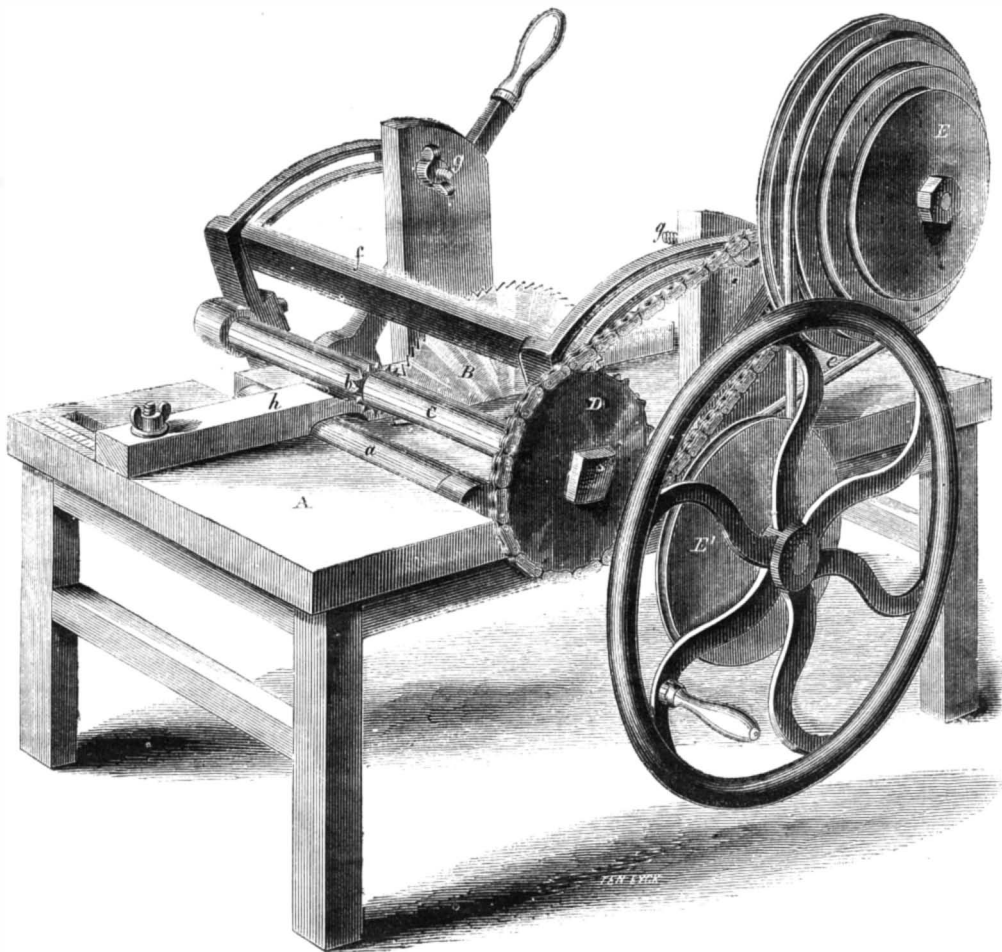

TALPEY'S PATENT SAW BENCH.

tained. The resisting force of a plate is in proportion to its thickness; and deflection is not secured by angulated plates against flat-fronted steel or flat-fronted wrought-iron projectiles.

To render Glazed Roofs Waterproof.

A correspondent of the London *Builder* says:—“Having seen it repeatedly stated that it was impossible to render a glazed roof waterproof when the ribs were of iron, in consequence of the expansion and contraction of that material, I beg to place on record in your columns the result of my experience to the contrary. Having long known the value of a compound of tallow and resin when laid on hot, with a lap of linen or calico, to fractures in water pipes, it occurred to me try it on the roof of my conservatory, which is of iron. It was laid on hot, over the sash-bars and putty; extending about a half or quarter inch on the glass. I have found this to answer admirably, as the mixture expands and contracts without breaking its continuity. The proportions I have used are two of resin to one of tallow.”

Printing in Colors.

Inventors have long sought to produce a press which should be capable of printing, at one operation, a number of colors. There have been many machines designed to effect this object, some of them working very successfully. We are informed that there is one press in this city capable of printing the seven colors at one operation; how correct this statement is we have no means of ascertaining. We can

say, however, from a personal inspection, that Messrs. R. Hoe & Co., the celebrated printing-press makers of this city, have invented a machine for the purpose alluded to, which does very good work. The one we saw working printed four colors, and did it well, too. The arrangement of the press, which we are allowed to make public, is as follows:—The paper to be printed is fed in from a table on to a cylinder the same as usual, but for every color which is to be printed there must be a separate form. For instance, supposing the national coat-of-arms to be the subject we desire to print in its natural tints, we must have one stereotype for the eagle, another for the red stripes in the banner and yet another for the “union” in the same. These are all arranged on a long platen in the order in which the colors occur; or so that they will alternate regularly in reference to their positions in the print. The feeding and distributing color-rollers are at either end of the platen and

are actuated similarly to other rollers. The paper remains upon the cylinder during the whole operation of printing, consequently the register is unchanged and the artistic appearance of the picture greatly improved thereby. For ornamental work, such as illuminated cards, posters and advertisements generally, this press seems to afford a neat and convenient machine which will doubtless be highly appreciated by the trade. It will be but a short time, we venture to say, before our illustrated papers will avail themselves of this invention, and present their readers with pictures done in the real “red, white and blue.”

A LARGE LEATHER BELT.—A leather belt was lately manufactured at Pawtucket, R. I., for a Western woolen mill, which belt was 120 feet (240 single) in length and 28 inches in width. It weighed 600 lbs.

The Norfolk Arms Company at Norfolk, Conn., are turning out about 70 rifles of the Springfield pattern daily.

IRON FOR SMELTING IRON.

ts which are employed in gas-works
of lation of coal, a coating of very pure
ometimes called graphine—gradually accu-
es. It adheres to the surface of the metal and
in thin scales. No other substance has been
ad equal to it for making the carbon points of
ectric lights. It has a metallic lustre, resembles
lack lead in appearance, and it makes marks upon
paper similar to those of a plumbago pencil. Carbon
is one of the most wonderful substances in nature.
Under different conditions, it possesses diverse
properties. In one state it is the brilliant diamond,
prince of gems; in another it is black opaque coal.
As plumbago, it is one of the most fractious of sub-
stances, it being used for crucibles in which iron
may be melted without producing the least appear-
ance of fusing it. How different are the properties
of plumbago, which cannot be burned, and the coal
which is employed to warm our houses and smelt
the hardest of metals; and yet they are the same
substance in a chemical sense. The carbon which
forms on the interior of gas retorts, although it is
very hard and greatly resembles plumbago, is
quite different in its nature as it respects combusti-
bility. At a high heat, it burns freely, and could it
be obtained in sufficient quantities, it would surpass
all other kinds of fuel for smelting iron. When
used in cupola furnaces for smelting pig iron to be
used for casting, three tuns of it will smelt as much
iron as five tuns of common anthracite coal. Being
so pure, none of the heat is absorbed—as is the case
with anthracite—by ashes, and as a consequence a
far more intense heat is generated in the furnace.
Indeed, the heat obtained in a cupola furnace from
gas carbon is so intense that it will fuse fire-bricks.
It is well known that the quality of iron is greatly
affected by the character of the coal that is employed
to reduce it from the ore, or melt it in the pigs for
casting. Very small quantities of sulphur and
phosphorus in the coal and coke employed for smelt-
ing iron tend to render it brittle and deficient in
tenacity. This is the reason why wood charcoal is
so superior for smelting purposes. It contains nei-
ther sulphur nor phosphorus, while mineral coal al-
ways contains certain quantities of them. In Pitts-
burgh and the Ohio valley very great value is at-
tached to those coal seams which contain the
smallest amount of sulphur, because such coal pro-
duces the best iron when it is used for smelting. A
discovery by which coke could be made from bitu-
minous coal as cheaply and as pure as the graphine
carbon in gas retorts would be a most valuable ac-
quisition to the practical arts. Iron could be smelted
with it at much less cost, and the quality of the
metal would also be vastly improved by its use.
Such a discovery should not be considered impossi-
ble, for this substance is derived from the very same
coal that produces common coke.

COAL TAR PERFUME.

Coal tar has a most disagreeable odor, and yet the
chemist obtains from one of its products a most
agreeable perfume. This is nitro-benzole—a com-
pound of nitric acid (aqua-fortis) and benzole. Coal
tar when distilled yields naphtha, which is a liquid
possessing great solvent powers. It dissolves gutta-
percha, india-rubber and many resinous gums.
Naphtha when distilled at a low temperature yields
benzole, which is a very volatile liquid. It has been
used for making gas for illumination upon a small
scale without distillation, but it is chiefly employed
for cleansing soiled gloves, silks, &c. It dissolves
grease and oils, hence its utility in cleaning light
colored soiled articles. Benzole combines with nitric
acid in definite proportions, and forms the heavy
oily-looking liquid called nitro-benzole. Its odor is
like that of the oil of almonds, and it is extensively
used in perfumery as a substitute for it. We have
also seen it stated that it is used in confectionary
as a substitute for the oil of almonds. This is a dan-
gerous application of it, because it is a poison, and
is deeply injurious to the human system when taken
in very small quantities. As a perfume, it may be
employed without much danger, but its use for this
purpose should also be avoided. It may be safely
assumed that it is not required excepting to disguise
unpleasant odors.

SORGHUM SUGAR—CONVENTION OF CULTIVATORS AND OTHERS.

A large convention of cultivators of the sorghum
and imphee and manufacturers of sirup and sugar
was held at Springfield, Ill., in the first week of
last month. Indiana, Illinois, Wisconsin and Iowa
were represented, and a number of inventors, having
improved apparatus and machinery for extracting
and concentrating the juice, were present. From
the conversations which took place at the convention
we learn that there is quite a variety of sorghum and
imphee. Mr. J. M. Moss, of Waverly, Iowa, related
some very useful experience. He stated that there
were five kinds of black imphee, one of sorghum and
two of yellow imphee. The large yellow imphee
ripens too late for seed, but in making sirup he
knew no difference between the different kinds. After
being made into sirup it all turns to sugar in eight
months afterward. Out of a quantity of sirup from
which 100 lbs. of sugar were obtained, there was only
one pint of sirup left. He makes sugar simply by
boiling down the sirup, and any process of evapora-
tion which obviates scorching is suitable. After
boiling down the sirup, he sets it away in a cool
place and allows it to stand, stirring it about once
per week, and without any other treatment it gradu-
ally granulates and turns into sugar. It is a singu-
lar fact that the sirup does not taste so pleasant
during the period of changing to the granular state.
Most of the 2,753 gallons of sirup which Mr. Moss
had made in the Fall of 1862 has now become granu-
lated, and he exhibited several samples of the sugar.
In obtaining sirup the cane is first crushed between
iron rollers and the juice transferred to evaporators
to be concentrated. Mr. Cory, of Indiana, exhibited
and explained his evaporator. He stated that the
Chinese sugar cane was the best for sirup and sugar,
and that Otaheitan seed was worth its weight in
silver.

A committee appointed to examine and report on
sugars and sirups stated that the samples were so
very numerous that they could not designate any
one as having a claim to superior excellence, but
considerable improvement had been made during the
past year in the manufacture generally. A committee
appointed on seeds reported that opinions were so
various that no definite conclusion could be arrived
at respecting the best kind of seed, but the yellow
imphee or African cane was the most suitable for ob-
taining sugar, and that seed of a medium size, be-
tween the largest and smallest varieties, appeared to
be excellent. More experiments, however, were
necessary to determine which was the best.

The conclusions arrived at from the proceedings of
this convention are that the cultivation of the
sorghum and imphee is a success in the great West,
at least for the production of sirup for home use, but
how far it will be practical to manufacture the sirup
and sugar from it for sale and export remains to be
determined. We believe it only wants perseverance
to insure complete success.

Rainbows.

We recently received a letter from a correspondent
in relation to primary and secondary rainbows, and
we have since found the following facts upon this
subject in the *Journal of Popular Sciences*:—

"There are frequently two rainbows seen, primary
and secondary; the former is by far the brightest
one, being formed by the rays of light falling on the
upper part of the rain drops; for a ray of light, en-
tering the upper part of a drop of water, will by re-
fraction be thrown upon the inner part of the spheri-
cal surface of that drop, where, undergoing a second
refraction it will be sent toward the eye of the spec-
tator. Since the rays which fall upon the primary
bow come to the eye after two refractions and one re-
flection, and the colors of this bow, reckoning out-
ward, are violet, indigo, blue, green, yellow, orange
and red. The secondary bow is formed by the rays
of light falling on the lower part of the drops of rain.
These rays, like the former, undergo two refractions,
namely, when entering the drops of rain and when
emerging from them in passing to the eye, but they
suffer two or more reflections in the interior surface
of the drops, hence the colors of their rays are not
so strong or so well defined as those in the primary
bow and appear in an inverted order."

Propositions to Supply the Navy Department.

The following propositions were received at the
Navy Department during the week ending December
13, 1862:—

Peck & Chase, New York, offer the steamer *Union*;
price \$35,000.

Cyrus Moore, Washington, offers eight steam pro-
pellers; price \$8,500 each.

Samuel Strong, Washington, offers *Broad's Patent*
Life-saving and Troop-landing Rafts, at \$800 each, pro-
vided not less than fifty are ordered.

Copeland & Howe, New York, offer the steamer
Clifton at \$122,400, and the *Oneata* at \$57,400; also,
to complete a steam-tug boat for \$41,850.

By the Bureau of Ordnance—Wm. Andrews &
Brother, New York, offer some superior old English
gun iron at \$45 per tun.

D. C. Sage, Middletown, Conn., offers to furnish
cartridges at the following prices:—Pistol cartridges,
with caps, in wood, \$13 per 1,000; without caps, in
wood, \$11 per 1,000. Rifled muskets, with caps, in
wood, \$23 per 1,000; without caps, in wood, \$21
per 1,000; with caps, in paper, \$21 per 1,000; with-
out caps, in paper, \$19 per 1,000.

Philip S. Justice offers to deliver in Liverpool gun-
blocks, manufactured of homogeneous cast-steel, at
£100 per tun.

J. J. Ashcroft & Co., Cincinnati, offer to make all
sizes of cast-iron projectiles, from best charcoal iron,
the ruling prices paid for them.

Novelty Works, Pittsburg, Pa., offer to manufac-
ture shell and shot for the Government at the same
prices others are paid.

E. D. Saxton and others propose to make arrange-
ments with the Government for the manufacture of
iron and steel in any quantities that may be desired,
and at prices which shall be a great saving, after the
improved smelting and refining process invented and
patented by E. G. Pomery, of New York. To enable
the parties to carry out their plans and establish the
works, they ask the Government to furnish the re-
quisite means, the estimated cost of which will be
\$100,000; to be applied and disbursed under the su-
pervision of an agent of the Government, &c.

By the Bureau of Provisions and Clothing—J. H.
Copeland, President of the American Desiccating Com-
pany, offers to furnish desiccated potatoes during the
ensuing year, at 13 cents per pound.

L. L. Anderson, Louisville, Ky., offers 100,000
pounds of tobacco at 60 cents per pound.

H. Chamberlain offers to deliver at the Brooklyn
navy yard 30,000 yards of standard blue flannel, at 65
per yard.

The "Alabama" Again.

The Anglo-Confederate pirate, *Alabama*, has again
signalized herself by capturing the California steam-
ship *Ariel*. There was a file of 120 marines on board
of the latter ship, who were paroled. The *Ariel* is an
old, side-wheel vessel, built many years ago. She
was at one time given up for lost, when in the trade
between Liverpool and this port, having been un-
heard of here for something like forty days. It was
ascertained, however, that she had put into South-
ampton on account of a broken shaft. She has a
beam engine, with a cylinder 65 inches in diameter
and twelve feet stroke. She is also slow in her move-
ments, so that the *Alabama* need not brag much over
this achievement. One of the express companies
lost \$8,000; this, with the arms and ammunition on
board, was the only reward the pirate obtained. We
live in the hope that before many days we shall have
the satisfaction of announcing that the steamer *Van-*
derbill has captured this rover, thus restoring confi-
dence to those who "go down to the sea."

PAPER STOCK.—Since the publication of our article
on the paper stock famine, we have received a great
many letters from persons residing in the country,
requesting us to either act for them in selling their
old papers or direct them to some one who will buy.
We cannot possibly attend to such business, and
would advise all parties who have paper stock to
sell to entrust it to their local merchants. The
prices here are fluctuating and unsettled.

The literati of Russia are chiefly Germans; the
mechanics and merchants, to a great extent, are
English and French; the bravest of her officers have
always been Poles, Cossacks and Britons.

MISCELLANEOUS SUMMARY.

AN AMERICAN CITIZEN DECORATED.—The Emperor Napoleon has conferred upon Col. John E. Gowen, of Boston, the order of "Chevalier of the Legion of Honor." The *Boston Herald* says:—"Col. Gowen has fulfilled his promise to clear the harbor of Sebastopol of the obstructions occasioned by the late Crimean war, but the work not having been performed within the time specified, the Russian Government seized and confiscated all the property accumulated by him, even the smallest articles, as well as all the apparatus sent by him from the United States, the value of which would not be less than \$200,000."

AMERICAN STEAMERS IN CHINA.—A gentleman residing at Hankow, China, in a letter dated Sept. 12th, says that a fine new American steamer arrived out there at the beginning of the week, for river traffic, and the captain gave a grand banquet on board to all Europeans in Hankow. She is a magnificent boat, with a splendid saloon, elegantly fitted up, is of about 2000 tons register, and beat Dent & Co.'s fastest steamer in the trip from Hankow to Shanghai. This must be the *Hankow*, built in this city some time ago. A large number of American steamers are now plying in Chinese waters and doing a thriving business.

HERE is a bit of English eccentricity in sufficiently bad taste even for John Bull:—Mr. Queensly, the Cambridge savior, a great admirer of the Greek poets, has given orders in his will that after his death his body shall be dissected and his skin taken off and tanned in such a manner as to convert it into parchment, on which the *Illiad* of Homer shall then be copied, the singular MS. then to be deposited in the British Museum. We should think "John" would make very good book-covers. The thickness of his skin would doubtless make a very durable binding.

Brazil is now the chief country in the world for the cultivation of coffee, and yet it is scarcely a century since it was introduced into that region. Previous to 1825, Java, Cuba, and the English colonies in the East and West Indies were the principal producers of coffee. Since that time Brazil has distanced them all. For a number of years she has produced for exportation nearly half the coffee of the world, and some years she even exported more than half. In 1809, Brazil only exported 3,000 bags; in 1861-2, no less than 1,633,114 bags were exported.

The year 1862 was one of the bad years for wine-growing in the West, and the crop was almost a failure. Less than one-fourth the usual average was realized. The very wet weather in May and June, 1862, caused first mildew and then rot in the grape. The quality of the wine manufactured, however, was excellent, owing to the richness of the grapes in saccharine matter, produced by the warm, dry weather in last August and September.

HOW TO MAKE GOOD TEA.—M. Soyer recommends that before pouring in any water, the teapot with tea in it shall be placed in the oven till hot, or heated by means of a spirit lamp, or in the front of the fire (not too close, of course), and the result, he says, will be, in about a minute, a delicious cup of tea, much superior to that drawn in the ordinary way.

A LADY in Boston was seriously burnt, recently, by the explosion of an air-tight can of tomatoes which she was heating upon the stove.

Charleston Harbor.

We are informed by an officer of the blockading squadron off Charleston, who has recently arrived in this city, that the Confederates have fortified that place most strongly; our informant assures us that they have no less than six large torpedoes which they can attach to rafts and float to any place in a few minutes, the torpedoes being wholly under control as regards the time and point of explosion. This officer thinks that the entrance of iron-clad vessels will be stoutly contested by the insurgents, they having, in addition to the above, an immense number of guns, whose fire converges on every point of the channel. It is well known that a narrow passage yet remains open through which vessels are obliged to proceed. This channel is well guarded by the means just mentioned.

Manufacturing Items.

Massachusetts.—The following items are condensed from the *Boston Commercial Bulletin*:—

The new set of machinery for the manufacture of horse-shoes, at the Goshold Mills, New Bedford, has been completed, and is now in successful operation.

The rolling mill of Charles Washburn & Son, at Quinsigamond, Worcester, so recently burnt, will be started again this week. The new building is constructed entirely of iron.

The Holyoke Water Power Co. have sold the property known as the old Smith Coffee Mill to the Hampton Mills. The building will be filled with cotton machinery, and is capable of containing 3,000 spindles.

Lamson & Goodnow, of Shelburne Falls, have rebuilt their factory buildings which were destroyed by fire a few weeks since.

The pocket-book and wallet shops in South Deerfield are running full time. Wm. S. Arms, formerly of the firm of Arms Brother & Co., has associated himself with others in the pocket-book business.

A novel machine has just been constructed at the Lowell Machine Shop, to manufacture kerosene and carbon oil lamp-wicks. The Excelsior wick (as it is called) is tubular, with raw cotton filling, having complete capillary attraction, making a perfect feeder for all the heavier oils. The wicks are cut off by the machine of the required length, of three sizes.

Maine.—In Biddeford some manufacturing business is in progress. The Pepperell Co. have a government contract, and their mills are now running about one third of their machinery all the time. The Machine Shop, in addition to a recent large contract for machines, has received another contract for furnishing the Porter Mill, at Lewiston, with \$50,000 worth of cotton machinery, besides a quantity of additional frames for Lowell, Mass.

The saw-mills at Gardiner are in active operation, business never being better than now, but the owners complain of the trouble they find in getting workmen.

Messrs. Allen & Warren, at their tannery, in Fryeburg, have just finished setting up and putting in operation a new leaching apparatus, by which liquor is obtained in a few hours (from clear water) nearly three times the strength of that heretofore got by the old way of leaching—the barometer indicating 30°—and containing less coloring and resinous matter.

A Rebel Infernal Machine.

A member of the Thirty-third Massachusetts Regiment, now in this city, has shown us a portion of a cartridge taken from a rebel prisoner, consisting of three cones, passing one within the other, something as one thimble would be placed in another. In a crease around these was found a white powder, connected by means of a thread, acting as a "slow match" to the powder of the cartridge. This was so arranged as to explode in a certain time after leaving the musket from which it might be fired, thus making the load consist of three projectiles instead of one. If an explosion should take place while the bullet was in the body of a person struck by it, it would make a terrible wound. The weapon used by the prisoner from which these cartridges were taken, was an Austrian musket, with a large bore.—*Boston Traveler*.

Trial Trip of the Iron-clad Battery, "Juniata."

Yesterday morning at half-past eleven o'clock the United States steamer, *Juniata*, arrived off the navy-yard in tow of the tug *A. E. Burnside*, and anchored off the navy yard. The vessel sailed from this port about a week since, but was obliged to return on account of some defect in her machinery. The following statement of the trip of this vessel is given by one of the officers on board:—

"Tuesday morning we left Philadelphia on our second trial trip, the first one having proved a failure. The engines worked well, pushing the ship through the water at the rate of almost eight knots per hour. Wednesday night we anchored near New Castle, and on Thursday morning proceeded on our way toward the ocean. At about noon on that day,

on attempting to start the engines with thirty pounds of steam we could not move either forward or backward, and connecting the eccentrics and removing the head valve slide, and bonnet, of the forward engine found that the lug was broken from the main valve, rendering it impossible to work the engine until a new valve is put in, which operation will require a week or ten days. It is the opinion of the engineers that the engines are far too heavy. Messrs. Peisey, Jones & Co., have performed their part well, and it is not their fault that the machinery failed."—*Philadelphia Inquirer*.

Demijohn Torpedoes.

It appears, according to the letter of a correspondent, who gives an account of the blowing-up of the *Cairo*, heretofore mentioned, that the torpedoes were made of ten-gallon demijohns filled with powder, and so anchored that they were about four feet under water. They were discharged by means of ordinary friction primers attached to cords designed to come in contact with ascending boats. They contained no machinery whatever, totally differing from the complicated and useless inventions sunk near forts Henry and Donelson, and above Columbus. This is the first instance in the war in which a boat has been injured by a torpedo. The means used in the present instance were as simple as they were effectual. The force of the explosion threw up a huge column of water that thoroughly drenched the men in the immediate vicinity. A hole of considerable extent was made in the bow, the planks being loosened and torn apart, so as to admit the water at a rapid rate. The entire boat was shaken from stem to stern, and her bow was lifted so high in the air that the water swept over the portion of the stern aft of the casemate.—*Pittsburgh Dispatch*.

The Usos of Walking.

Walking for young and active people is by far the best exercise; riding is good for the elderly, middle-aged and invalids. The abuse of these exercises consists in taking them when the system is exhausted, more or less, by previous fasting or by mental labors. Some persons injudiciously attempt a long walk before breakfast, under the belief that it is conducive to health. Others will get up early to work three hours at some abstruse mental toil. The effect in both instances is the same; it subtracts from the power of exertion in the afterpart of the day. A short saunter or some light reading before this meal is the best indulgence of the kind; otherwise the waste occasioned by labor must be supplied by nourishment, and the breakfast will necessarily become a heavy meal, and the whole morning's comfort sacrificed by a weight at the chest from imperfect digestion of food. These observations apply especially to elderly persons, who are prone to flatter themselves into the persuasion that they can use their mental or bodily powers in age as in youth.

The Early Days of Steam Locomotion.

The Patent Museum at South Kensington, London, has lately received a very interesting addition to its contents, in the celebrated "Rocket" engine, constructed by the late George Stephenson in 1829, and which, it will be remembered, competed successfully at the famous trial of locomotives at Rainhill, near Liverpool, in that year. The engine, which is extremely curious, is wonderfully perfect, bearing in mind its age and the hard work that it has gone through. An inscription states that many missing parts have been restored by Messrs. G. R. Stephenson & Co. Near this engine stands the "Puffing Billy," which was constructed in 1813, for Mr. Blackett, the proprietor of the Wylam collieries. This is the oldest locomotive in existence. After many trials and alterations, it commenced working in 1813, and continued working until June, 1862, when it was removed to the Patent Museum.—*London Athenaeum*.

The cranberry crop in Barnstable county, Mass., in 1862, reached 1,525 barrels, which were sold for \$12,250 60.

MILES GREENWOOD, of Cincinnati, has made for the army and navy twenty-nine batteries of brass guns, at a cost to the Government of \$23,000.

LUABLE RECEIPTS.

ABLE CLOTHES.—Cotton and linen cloth-ry inflammable and during the winter season fatal accidents occur from clothes taking fire. Wool or other clothing made of wool should be exclusively for the winter clothing of children, on account of their warmth and their greater safety from fire. Wool and silk do not inflame when they come in contact with fire, but singe away slowly; and when cotton cloth is so high in price, woolen cloth may be considered the most economical for wear because it is the most durable. Woolen cloth and flannel are generally held to be uninflam- mable fabrics. Cotton and linen clothes however will always be worn to a great extent when they can be obtained; therefore, a knowledge of the mode of render- ing them non-inflammable, to the same extent as woolen clothes, will be useful to very many persons. This is a subject which has engaged the attention of chemists and others for a long period, and various modes and compositions have been tried and used to prepare such fabrics and impart to them non-inflam- mable qualities. Gay Lussac made a great many ex- periments with linen and he found that the chloride of ammonium (sal ammoniac) the sulphate, the phos- phate and borate of ammonia rendered it inflam- mable. In 1857 a mixture of three parts of sal am- oniac and two parts of phosphate of ammonia was patented in France for rendering linen uninflam- mable, and it is a very good composition for this purpose. It is dissolved in water, the solution being moderately strong, the cloth handled in it and per- fectly saturated, then taken out and dried in the at- mosphere. Among the numerous substances and compounds which have been tried, the sulphate of ammonia and the tungstate of soda are stated to be the best by Messrs. F. Versmann and A. Oppenheim, London, who are engaged in the business. A con- centrated solution of tungstate of soda diluted with water to 28° in Twaddles' hydrometer, and then mixed with 3 per cent of the phosphate of soda, is used in the laundry of Queen Victoria for pre- paring muslins. The clothes are immersed in it, then wrung out, dried and ironed. The tungstate of soda may be mixed with starch and thus applied in a very convenient manner. About one ounce is sufficient for a pound of starch. No sub- stance that absorbs moisture after the clothes are dry should be used for mixing with the starch of clothes or for treating them in solution.

Sail cloth has been rendered uninflam- mable as follows:—Two parts of the protochloride of tin (a com- mon salt of tin sold by druggists and others) are dis- solved in one of water, and according to these pro- portions the solution is made in such a quantity as will cover the extent of sail cloth to be treated. The canvas is then soaked for two days in this solution; then soaked for one day afterward in another strong solution of the carbonate of soda. The sail cloth is then rinsed in cold water and again dried. Salt water will not remove this substance from the canvas. Such a preparation tends to prevent mil- dew in the canvas, but it also weakens the fiber of the cloth. These substances also render paper non- inflammable.

PUTTY.—A very good substitute for putty may be easily prepared by mixing calcined plaster-of-paris and water to the consistence of thick cream. It should be prepared in small quantities and applied immediately, for it quickly hardens, when it loses its plasticity. For repairing broken windows, when putty is not at hand, it answers a very good purpose.

THE MINERAL RICHES OF THE LAKE SUPERIOR REGION.

Copper and iron are found in exhaustless quantities in the Lake Superior region, forming the northern peninsula of the State of Michigan. Their existence has long been known to geologists, but it was not till the completion of the Sault St. Marie Canal, in the year 1855, that these mineral treasures became commercially available. Since that time, the great impediment to transportation being removed, the resources of the districts severally known as Ontonagon, Keweenaw Point, and Portage Lake have been wonderfully developed. The aggregate value of copper exported from these points in the year 1845 was \$890; in 1860, the amount reached \$2,944,000.

Seventy sail of vessels and twelve steamers were in- adequate to do the business between ports on lakes Erie and Superior. Yet the assertion is made that "we have only reached the morning of copper won- ders." The great range comprised within the districts above-mentioned for the most part remains in its primeval state, though mining is being practically methodized; the most approved apparatus is in course of introduction for stamping and separating the rock; and the time is looked forward to, as not far distant, when this region will supply the demand not only of the United States but of Europe. The U. S. Mint refuses to receive any but the pure metal to be obtained from Lake Superior. The most ex- traordinary features, however, presented by the mines of Lake Superior, are the enormous masses of pure copper blasted out at various points, some of them weighing 300 or 400 tons.

The copper stamping mills generally stop once per year to make repairs, and an account of the year's work is generally made out at the period of stoppage. We learn from the *Mining Gazette* that, during twelve months' operations in 1862, the five stamping mills on Portage Lake crushed and washed 130,000 tons of rock, and taking 100lbs for each cubic foot of rock, it amounts to 2,600,000 cubic feet. On Portage Lake, within a radius of five miles, there are seven copper mines in operation. Their produce in 1862 was over 4,000 tons of copper. The Isle Royal mine is the oldest in the district; it has been opened to a depth of 474 feet. It produces stamp work, that is, the rock containing copper is crushed by stamps, then washed, the debris being carried into the lake, and the copper, containing about fifteen per cent. of impurities, is retained for smelting.

The deposits of iron in this region are of great extent, and in several places they form hills of ore several hundred feet in height. The mines (or quarries, for the ore is simply thrown down by the use of powder from the side of a cliff) are fourteen miles back from Marquette, at which point several blast furnaces are now in operation. Large quantities of Lake Superior iron ore are exported to Ohio, lower Michigan and Pennsylvania, where it is made into pig iron. As every special kind of ore requires special treatment, considerable experience is necessary in the smelting of this ore. We have been informed that the pig iron obtained from it in some establishments is of an inferior character, it being what is called "burnt iron;" while in other establishments pig iron of an excellent quality is obtained. These dif- ferences of quality in iron obtained from the same ore are due to differences in the modes of treating it in the smelting furnace. As it is a very pure ore, we have been told that it should be smelted under a moderate blast, and a comparatively "low head" of furnace.

FATTENING OF POULTRY.

In the hands of many persons the fattening of poultry has almost become a science. They know how to take a lean turkey, for example, and so feed it as to double its weight in a few days, and at the same time they render its flesh savory and agreeable. There are two modes of feeding poultry for fatten- ing; namely, the natural and the artificial methods. The former is that most generally pursued in Eng- land and America; the latter is the French method. The natural mode consists in allowing the fowls a degree of liberty in the barn-yard, and supplying as much nourishing food as may satisfy their appetite. This method is generally preferred in America, and many experienced poulterers affirm that they can obtain as good fowls in this way as by any description of forced feeding.

The artificial method consists in forcing food at regular intervals down the gullets of the fowls. This food consists of a mixture of corn meal, milk and water; or, as in France, barley meal, which is fed by means of a filler and funnel, the latter being made of tin with an india-rubber ring on the bottom to pre- vent injury to the throats of the birds. Some per- sons instead of using a filler, employ the finger for stuffing down the food, which is prepared in a more solid form, and consists of a hash made of boiled potatoes, corn meal, sweet milk, and finely chopped suet. During the period of artificial feeding, the fowls are kept in boxes, which are well littered and

placed in a moderately warm situation. They are usually fed three times per day, and the period of fattening is from fifteen to twenty days. In apply- ing the food with a funnel, the fowl is seized by the wings near the shoulder, the head is held forward between the knees and grasped by the left hand; the beak is opened, the funnel inserted, and the proper quantity of the mixture poured down. Two persons can feed quite a large number of fowls in this man- ner in a very short period.

Some persons who make a business of fattening poultry are exceedingly careful of the food which they apply, and they keep their mixtures somewhat secret, ascribing a mysterious influence to their par- ticular modes. A mixture of boiled Indian meal, mashed potatoes and sweet milk, with a little finely chopped suet, is as good food for turkeys as can well be provided. Fowls should always have access to gravel during the period of fattening, as they swal- low small stones, these being found necessary to pro- mote digestion.

Some feeders of poultry assert they can give the flesh of fowls any particular flavor they desire by the kind of food which they give to them. This is probably true, as the flesh of wild game acquires the flavor of the berries and aromatic buds upon which the birds feed.

APPLICATIONS FOR THE EXTENSION OF PATENTS.

The following persons have applied to the Commis- sioner of Patents for the extension of their patents for a term of seven years:—

Steam Engine.—George H. Corliss, of Providence, R. I., obtained a patent on March 10, 1849, for an improvement in steam engines. This patent was surrendered and re-issued on the 13th of May, 1851, and again surrendered, re-issued and divided into six patents on the 12th of July, 1859, said patents being numbered respectively Nos. 758, 759, 760, 761, 762 and 763. The patentee now prays for an extension of the last patent (763). The testimony will close on Feb. 9, 1863, and the petition will be heard at the Patent Office on the 23d of that month.

Cutting Teeth of Beveled Gear.—George H. Corliss, of Providence, R. I., obtained a patent on March 10, 1849, for an improvement in cutting teeth of beveled gear. The testimony will close on Feb. 9, 1863, and the petition will be heard at the Patent Office on the 23d of that month.

Loom.—Erastus B. Bigelow, of Boston, Mass., ob- tained a patent on March 10, 1849, for an improve- ment in looms for weaving Brussels carpets, &c. The testimony will close on Feb. 9, 1863, and the petition will be heard at the Patent Office on the 23d of that month.

Persons who wish to oppose the extension of these patents should attend to it without delay. Copies of the claims in each case will be promptly forwarded from the Scientific American Patent Agency upon the receipt of \$1.

Great Ages of Trees.

There is "a glory in trees" as they lift their tall branches on high, giving shelter to the merry squirrel or the singing bird in summer; or when forming Eolian lyres in winter as the winds sing in their leafless boughs. There are many trees which have become sacred by the endearing associations of family scenes. Generation after generation con- nected with the old homestead have sported beneath them in infancy, and reclined in their shadow in old age. That exquisite ballad, "Woodman, spare that tree!" is brimful of poetry, because it is full of truth and vibrates on the tendrils of every heart.

Some trees attain to a great age. In a recent lecture on geology by Mr. Denton—delivered in Montreal, C. E., and reported in the *Gazette* of that city—he said that there was a tree cut down in Cali- fornia 96 feet in circumference. He had counted on a block of it, shown in Wisconsin, 13 rings of annual growth to an inch! Here then was a tree 2,496 years old—a tree that was a sapling when Nebuchad- nezzer was a boy—that was nearly 200 years old when Socrates was born. A yew at Forthingall, in Scotland, was calculated to be 2,600 years old, and one in Kent, 3,000. There was a tree in Senegal in which an incision was made and the concentric rings counted, from which it was calculated to be 5,150 years old!

TOBACCO.

Perhaps the most eminent vegetable the earth has ever produced is that one which we shall discuss in this article in its several bearings upon society—in a pecuniary, physical and in an esthetic sense. We have made the assertion and have taken the bold ground at the outset, that tobacco was the most distinguished member of the agricultural kingdom, and we reiterate and maintain our position by these arguments:—From remote ages, even when Sir Walter Raleigh sat in his library soothing his philosophical mind with the smoke from a pipe, down to the present time, it has been the choice companion and chief solace of the most eminent and worthy men of science that the world has produced. Poets have sung its praises in all meters and with greater or less enthusiasm, encomiums have been pronounced upon it, words have been declared weak to express its virtues, in short, the whole vocabulary of complimentary adjectives has been exhausted in its honor. Thus has it been distinguished. But the truth of history prompts us to admit that the opposition tobacco has met with, though not in the least detracting from its popularity or its stability in the public estimation, has been, at any rate, no less vehement after its kind than the opposite fact. The pulpit has thundered its fulminations at it unavailingly; preachers have composed sermons, and lecturers have made "raids" upon the weed with, as they fondly imagined, the most terrific onslaught and unqualified success; but alas! the fact remains indisputable and unchanged, that there is more tobacco used to-day than at any former period of the world's history.

Whether we may attribute this to the obstinacy of human nature, or to the energy of the great family of nations in overcoming obstacles that are opposed to them, or to its cheapness, is a question which we shall not here discuss; what the causes are which lead to its increased consumption we cannot determine; the simple, isolated fact that it is so, stands incontrovertible. There may be some ingenuous spirits who would be disposed to deny our dictum in that tobacco is the most widely-known of the vegetable kingdom, and attribute those honors of popularity with which we have crowned the narcotic weed to cotton. They may ring the changes in vain upon that trite theme. The sound of the guns which daily thunder upon our Southern coast and States and of those which so rudely smote the walls of Sumpter dispelled any lingering doubts we might have had as to which of the potentates rightfully claimed our allegiance. Cotton is not king. A man may go without a shirt gladly, but deprive him of his tobacco and there will be a hiatus in his nature, which, when he is once under the influence of tobacco, nothing can supply. Nay, he may be so entirely uncivilized as to be wholly independent of those wants and usages which society has declared indispensable. Cotton in any form may be to him a drug and a detestable nuisance, a pocket-handkerchief may be more cumbersome than its bulk in lead. But if we search in the turban of the Bedouin Arab or the folds of talpa cloth which are wound about the loins of the indolent Otaheitan, we shall find some little store of the precious weed hidden in its folds, secure and unattainable save to his own personal fingers. Or of what value indeed is corn, wheat, in brief, any cereal, to him who is deprived of his matutinal cigar, pipe or other instrument that man employs to titillate his throat and nostrils with the pungent smoke? Simply of no value. The prisoner in the jail will deprive himself of a portion of his scanty ration so that he may have his tobacco-box full. The devotee to this luxury will deny himself food and even clothing, so that his craving for tobacco be allayed. But who ever heard of the contrary practice? Does the Arab give his "plug," supposing him to have such an article, for a new turban? No. Or will any semi-civilized fragment of humanity barter away that, to him, priceless roll which, while he is under its influence, merges kingdoms, principalities, powers and poverty into one grand brotherhood.

Assuming conviction to be irresistibly carried to the minds of our readers by these arguments, let us dwell first upon the production of tobacco in our own land. It is grown to some extent in the Connecticut Valley, but for the finer kinds a richer soil and warmer climate are required. In the *California Farmer*

we find a few remarks on the cultivation of this staple in that State. It is estimated that 1,000 pounds per acre of Havana tobacco could be produced there. The principal sources of supply, however, were found, previous to the war, in the Southern border States, Kentucky, Tennessee, Virginia and to some extent, Southern Ohio and Missouri. Illinois has also grown tobacco, though not as a staple, we think. The plant is emphatically a tropical one, and flourishes much better under calm skies and lazy treatment than with our energetic Northern cultivation. Perhaps, the gentle tickling the slaves give it with hoes is better adapted to the secretion of its wondrous juices than the vigorous attention it receives from patent plows or drills. Evidently, some causes conspire against the successful growth of the choicer brands of the weed at the North. These will be discovered in time, and if the difficulties are inherent in the plant or only local, they will be surmounted and Northern "grit" will bring to market tobacco grown under shelter, of a finer quality than ever. So far as relates to the Southern States, all our intelligence goes to prove that but very slender crops have been planted this year—as would naturally be the case in a country disturbed by war. All ruminants, therefore, must expect to pay an increased price for their consolation.

But let us look at the effects produced by tobacco upon the human body—that wonderful organization which repulses with more or less vigor the assaults of poisons in every shape—of fever, of hunger and thirst and all the ills that besedge its many fortresses. Let us see how we shall fare if we make the weed our lingual and labial friend. Ree's *Cyclopaedia* says that a drop of the oil placed on a cat's tongue causes convulsions and death in the space of a minute; and certain of the wise medical men of the day have declared that not less than twenty thousand in our land die annually by the use of tobacco. Dr. Shaw names a catalogue of some eighty diseases which, he says, may be traced to the use of this poison; and yet another authority asserts that a relative used the weed to such an extent that he literally *snuffed* the light of his existence out. Dr. Twichel believed that tobacco was the cause, not unfrequently, of sudden deaths. Bocame, of Belgium, was murdered in two minutes and a half by the use of nicotine or alkali of tobacco. Three young men formed a smoking club and they all died within two years from the time they had instituted it. A doctor gave it as his opinion that they fumigated themselves to death; this worthy must have been akin to Dr. Aiken, who declared that if he wished to make a sacrifice to the devil, he would take a pig and stuff it with tobacco. A boy of eighteen fell dead in a dramshop with a cigar in his mouth; the verdict on this feat was that he died by the mysterious visitation of God; physicians said it was the heart disease, but a person knowing the youth's habits said it was tobacco that killed him. It deranged the action of his heart, which, ceasing to beat, caused him to fall. Still another shining light of science says of the weed in question, that it is an acid narcotic, a few grains of which cause death; that it is a source of intemperance, induces drinking, brings on jaundice, and, closing all, death.

These are, doubtless, learned opinions and reliable ones, but some of them bear traces of intolerance and bigotry. It is comparatively easy for one having an antipathy against a certain article to search the cyclopedias and bring ponderous bolts to bear upon it, and so endeavor to batter it out of existence. In this case, unfortunately, tobacco, the object of all the disquisition of which the opinions above quoted are extracts, refuses to be abolished; and people smoke, chew and snuff with, as the novelists say, a perseverance worthy of a better cause. It may be indeed that the philosophers before-mentioned have at one time been made deadly sick by too ardent an application to their idol, and conceiving therefore, an intense dislike for it, have resolved upon its ruin. We cannot think that their wishes will be realized; the effects of tobacco are undoubtedly bad, as is, in fact, water or anything harmless *per se*; taken in excess it gives distress and all the symptoms of sudden death so feelingly alluded to heretofore. Of the large majority of deaths in the country it is saying a great deal to assert that twenty thousand of them are caused by narcotics in the shape of tobacco. We are not of those, therefore, who make a hue and cry

against customs and habits without a surer basis than mere hearsay evidence, and we cannot expect that any one will throw away his cigar on the instant because we have printed Dr. Dryasdust's opinion. Our mission is fulfilled when we point out the results likely to ensue from the abuse of it. Neither do we advocate or decry its use, conceiving it to be for the interest as it is the solemn duty of all men to inquire into their habits so far as they bear upon the preservation of health; not present comfort more than the welfare of future generations depends on their practices.

The Turks undoubtedly understand how to smoke better than any other nation. They do not seem to be harmed by it, since they live to healthy old age in the constant use of the weed; but whether harmed or not, they evidently excel all other people in the luxury. The Turk smokes a clean clay pipe. He also uses a long wooden stem. This is the important characteristic of the chibouk, and the theory of the thing is this:—All woody fibers in burning are decomposed, giving off quantities of water or of oxygen and hydrogen, which compose water. This water passes off in steam or vapor, having in solution the nicotine and other component parts of the tobacco. What is commonly called the "oil" in a pipe is ninety-nine hundredth parts water. It cannot but be evident that this hot water or steam, passing as it does directly from the fire to the mouth when one smokes a short pipe or a cigar, is uncomfortable, if not unwholesome. A long wooden stem, three to five feet in length, with a large bore, is therefore advantageous in this respect, that it permits the smoke to rest in the tube some time before it is taken into the mouth. It deposits its steam and a large part of the nicotine in the wooden tube, and the smoker takes into his lips a dry smoke. The Turks clean these stems daily with strong coffee. They prefer the wood of the jessamine or the wild cherry to all others, although they make pipe stems of every kind. Indeed it is not uncommon for a luxurious Turk to send out for the branch of a large rose-bush, have his servant bore the stem with the ever-ready gimlet and string, and then hand the pipe to his guest blooming with fragrant roses. Jessamine and cherry stems cost in the Turkish bazaars from one to ten and even fifteen dollars each. It is on the stem and the mouthpiece that the expense is wanted. The amber mouthpiece is in itself costly—choice amber, milky and delicate in color, being worth almost its weight in gold in Oriental countries. The mouthpiece is ornamented with jewels, according to the wealth of the proprietor. Thus, a mouthpiece worth ten or twenty thousand dollars may be frequently seen, while the bowl of the pipe is worth but a tenth of a cent.

These "habits and properties," as the theatrical men say, may be very well for Turks, but at the present state of prices such luxury could hardly be supported. A paragraph in a late paper says that a gentleman in this State has recently built a three-thousand-dollar "smoke-house." Or more properly, perhaps, he has just converted the cash, which would otherwise have been blown to the winds, into a substantial dwelling. Finding that the habit was injuring his health he discontinued the practice. He was encouraged by the pecuniary saving it was constantly effecting. By an accurate arithmetical calculation he ascertained that the daily cost of cigars, with annual and compound interest, would amount to over three thousand dollars in twenty years. Having already effected this saving he concluded to build a handsome dwelling. We should regard this as a most precarious investment. The fear would be always recurring that at some day fire and smoke would claim their own, and that the house would vanish from the earth as swiftly as the blue rings from the cigar, at whose expense it was erected. Finally, we may assert without the fear of doctors before our eyes, that the use of tobacco like every other indulgence is injurious to some while it is innoxious to others. Practiced to excess the habit will lead to serious evils, but a very temperate use of this celebrated vegetable will not be attended with any worse results than a gradual but steady diminution of its devotees' loose change.

A LIVE gorilla has lately arrived in Liverpool from Africa, and is the first living animal of the species that has been brought to Europe.



The Properties of Guns and Projectiles.

SIRS. EDITORS:—At a time like the present, when the ingenuity of man is taxed to its utmost capacity in the contest between armor clads and artillery; when the strife for the mastery is still undecided, it will be permitted in an individual who is a believer in great guns, to record his testimony and experience in their favor, and if necessary, to demonstrate by trial the great superiority of guns over anything which has, as yet, been constructed or projected to baffle their power. General Haupt, of Washington, in a series of interrogatories recently published, furnishes an excellent opportunity to the friends of the two antagonistic arrangements to give their views on the subject; I will therefore give my views and also answer some of the questions propounded.

To his query, "Have you given any attention to the subject of ordnance in connection with iron armor for ships of war?" I can say:—"I have; during the last twelve months that subject has had much of my time and attention, experimentally and otherwise."

"What is your opinion of the propriety of placing 15-inch cast-iron guns in the turrets of the *Monitors*?"—"For the perforation and actual demolition of iron and stone structures, the charge for a smooth-bore should not be less than one pound of powder to three pounds of shot, and for a rifle gun not less than one pound of powder to four pounds of shot. The 15-inch guns will not bear such charges, and are consequently unfit to do that kind of work. They are, undoubtedly, good shell guns, but time will show that they are wholly unfit to throw solid shot."

"Can a high velocity be given to a projectile without a heavy charge of powder in proportion to its weight?"—"Certainly not; after reducing the windage and friction of the shot in the barrel to a minimum, the work remaining must be performed by the powder."

"Does a large diameter of projectile with a given velocity reduce the power of penetration, and in what ratio?"—"The resistance to penetration is directly as the diameters of the projectiles; a shot $7\frac{1}{2}$ inches in diameter meets with half the resistance that one of 15 inches experiences."

"What should be the ratio between the powers of penetration of a projectile 15 inches in diameter, moving with a given velocity, and a projectile of equal weight and half the diameter, moving with double the velocity?"—"Conceding it to be true that the penetration of projectiles is directly as their weight, while it is as the square of their velocity, the ratio is as eight to one in favor of the smaller diameter."

"Is it probable you could, with equal safety to the gun, impress upon a projectile from a $7\frac{1}{2}$ -inch bore, nearly double the velocity that could be given a projectile from a 15-inch bore?"—"It is possible to more than double it, as the 15-inch gun is now used; inasmuch as a solid shot weighing 75 lbs. can be fired from a $7\frac{1}{2}$ -inch rifled bore with safety to the gun, with a charge of 25 lbs. of powder; while the lightest solid shot used in the 15-inch gun is of cast-iron, spherical, and weighs about 425 lbs., and the maximum charge for the 15-inch gun is, I believe, 50 lbs. of powder."

If in the case of the large shot, an initial velocity of 1,050 feet is attained, per second, in the other it will not be much less than 2,500 feet. The power of demolition will be as great in the small shot as in the large; while that of perforation will be as two to one in favor of the former. During the earlier part of my investigations of this subject, it occurred to me, that guns of a large diameter of bore might be made more effective by placing shot of a less diameter in a wooden sabot made to fit the bore, in this way a shot 10 inches or of any other desirable diameter, might be fired from a 15-inch gun with a charge of 75 lbs. of powder or more, with perfect safety to the gun. This plan will not answer, for the reason that it would be impossible to

give accurate direction to the shot, save for very short distances.

Rifled cannon must, in all cases where solid shot are used, take the place of the smooth-bores. It is a great mistake to suppose that a much higher velocity can be attained from the latter than from rifled guns. If the proper proportion of powder and shot are used, the difference in velocity will be trifling, while the advantage in accuracy will be largely in favor of the rifled gun. The charge for a 100 pound Parrot gun is 10 lbs. of powder, the caliber being $6\frac{1}{10}$ inches, the same as the 32-pounder smooth-bore. The 100 lbs. shot is equal in weight to more than three solid spherical shot for the same gun. If, in this case, the shot were reduced to 50 lbs. and the charge of powder increased to 15 lbs., greater range and greater power of penetration and demolition would be attained than it is possible to give the heavier shot, with the necessarily light charge of powder. These opinions are based upon research and experiments carefully made. M. RITNER, C. E.

New York, Dec. 30, 1862.

Wintering Bees.

MESSRS. EDITORS:—To winter bees successfully in our cold Northern climate is a question of great moment with every apiarist. There seem to be almost as many ways recommended as there are bee-keepers. Having had several years experience in this business in Northern Vermont, I have arrived at this conclusion, that bees should have for their welfare in winter a *dark, cool, dry, still* place, where the temperature is as even as possible, and about five degrees above the freezing point, or 35 degrees Fahrenheit. In this temperature the bees will remain very still and quiet, and will require but little honey to what they would if kept in a warmer place.

In the first of my experience, I was advised to put my bees into a tight dark room in the house. I did so, and the consequence was I lost many of my bees before spring. During the warm days in the winter the bees would become very lively and crawl out of the hives upon the floor, and if there was a ray of light they were sure to find it, and would there perish; if shut into the hives, they would create such a heat in trying to get out that they would melt their comb and become drowned in their own sweats. This I found was owing principally to the outside temperature being so changeable and the want of proper ventilation.

Wintering bees out of doors, as practiced by a large proportion of amateur bee-keepers, is always attended with bad results, as nearly one-half of the stocks are frequently lost, and those that are not are so reduced in number that they will not swarm in the coming season, there not being bees enough to permit of it, consequently are worth but little to their owners. When bees stand out of doors, every warm day during the winter they are inclined to fly from the hive, and thousands of them get chilled and are lost, and where there was a peck of bees in the hive in the Fall, by spring there may be but a handful left. In the Middle or Southern States, bees can be allowed to stand out of doors during the winter with safety. In my more recent observations and experiments, especially in the Northern States, I have found no place to winter bees in equal to a *dark, dry cellar*.

If the hives are rightly arranged, and the cellar ventilated by opening either a door or window in the night time, occasionally, there will be no loss of bees only what die of old age, and the comb will look nearly as white as in the Fall previous. Bees, when kept in a cellar of this kind, will not make a discharge to soil the comb during the whole winter, and will consume but a very few pounds of honey—say about a pound to a thousand bees; for ordinary swarms it would require from ten to twenty pounds of honey. At this low temperature the bees will remain very quiet and still, and if the cellar is kept perfectly dark they will remain so during the whole winter, and will hardly know when spring approaches, which will not be the case when kept in a room above ground or out of doors. Bees frequently receive more injury in being confined in the hive on the approach of spring than they will if allowed to fly out.

The time to put bees into winter quarters depends somewhat upon the severity of the weather—usually the last of November or the first of December; if the weather is not too cold, they may safely remain until

near January. They generally suffer more in the latter part than in the beginning of winter.

As to the position of the hives when placed in the cellar, if straw or the old-fashioned board hive is used, it should be turned bottom-side up with the bottom boards removed. Their animal heat will then drive all the dampness and mold out of the hive. The only disadvantage in turning a hive bottom-side up, is, all the dead bees and particles of comb will drop among the combs in the bottom of the hive. But if there is honey enough there will be no trouble resulting from it, as when the hive is carried out-of-doors, and placed right-side up, the bees will readily clear it out. If movable-comb hives are used, the cap, boxes, &c., should be removed and the hive allowed to remain right-side up, with the entrance closed.

The time to remove bees from the cellar depends in a great measure upon the forwardness of the spring, and care should be taken that the weather is warm enough, that the bees can safely fly from this hive and return again, always observing to never set but a part of the hives out on the same day, and always place them as near as practicable on the same stand that they occupied the year previous, to avoid confusion and robbery.

After the bees have all made their excursion, as they always will do on the first day, and discharge themselves, thousands of bees might then be saved by setting them back into the cellar again for three or four weeks, and at the same time supply each hive with a substitute for bee bread, which is rye meal (or common flour will answer), as bee bread or pollen is the first thing the bees will visit the fields for in early spring; by supplying them with this useful article the lives of a large number of bees will be saved, which if allowed to stand out would be lost.

Burying bees in the ground is a practice that some inexperienced bee-keepers have resorted to, and not unfrequently with fearful loss. The object aimed at seems to be the low, even temperature that our cellar affords. In a light, loose, sandy soil, if the bees are properly buried, there are instances where they have lived through it. I have frequently heard it remarked by those who advocate this process that the hives were as heavy in the spring as they were in the Fall before; should the bees all perish as I have repeatedly seen, this theory might prove true. I have yet to learn if bees can be wintered in any place without consuming some honey. It is true, if bees are kept in a damp place and should they survive the dampness, the amount of honey they will consume will be small, the weight of which would be balanced by the dampness and mold which the combs will take up, so that the hive would be nearly as heavy in the spring as it was in the Fall previous.

K. P. KIDDER.

Burlington, Vt., Dec. 31, 1862.

Pulpit Lights.

MESSRS. EDITORS:—A convenient method of lighting the desks of pulpits, so as to illuminate the manuscript without offending the eyes of the preacher or the congregation, has long been a desideratum. By the usual arrangement of candelabra on the front of the desk, which seems to be in most churches the only way of arranging them, provided their elevation be sufficient, which is not always the case, the reader may be protected from the glare of light across his face, or that reflected from the paper on the desk, but the auditory are always annoyed by the effect of the rays which, diverging from the gas jets, cross and interrupt their vision. It is said that in some churches in Holland this is obviated by placing concealed lamps upon the huge canopy sounding boards which surmount their pulpits, and passing their lights through slits therein, which direct their rays down upon the desk. There is to be seen in the new St. Paul's church, Albany, N. Y., a novel mode of accomplishing this object, which seems to the writer so admirably arranged that it should be made known extensively as a matter of general interest:—The pulpit being an octagon in form, its desk is small, not much larger than a large folio bible, and is like an ordinary writing desk in shape, having a raised back of about four inches high, and sides starting from the ends of this back, sloping down to the front edge of the desk. Along the angle formed by the junction of the desk and this back a small pipe is laid, pierced

on its upper surface with six small holes for gas jets. Behind and over this pipe, rising up nearly to the top of the back, is a metal reflector whose upper part curves over and forward, forming a hood to intercept the light from the eyes of the reader, a small slit being made along its upper edge to pass off the heated air from the gas. By this arrangement the light is reflected from the jets in lines slightly downward, so as to illuminate the bible or manuscript page brilliantly, the rays reflected from the surface of the paper passing off at a very slight upward angle, so as to permit a very bright illumination of the page, without the inconvenient and injurious effect of the direct return of the light from the page to the reader's eyes. The gas tube of the desk is connected with the tubing of the church by a flexible joint, so as to allow the desk to be raised and lowered a few inches. This ingenious and beautiful arrangement was introduced by the architect of the church, Mr. William Hodgins. D.

Albany, N. Y., Dec. 30, 1862.

The "Scientific American" as an Advertising Medium.

There are comparatively few, even of our own readers, who fully appreciate the value of the SCIENTIFIC AMERICAN as an advertising medium. Doubtless one reason for this arises from the fact that we have never made advertising a particular feature of the paper. We cannot forbear, however, to publish the following letters from two of our oldest patrons. These letters speak for themselves.

GENTLEMEN:— * * * * * Let me say for the SCIENTIFIC AMERICAN (and you are at liberty to use my name publicly or otherwise), it is the only newspaper I ever advertised in, that does not require the exercise of faith. It always, *invariably pays me*; and that, too, within a fortnight; and I know it. Faith in this matter of advertising has ruined many a man. I am glad to know that your paper gives me something substantial and tangible—that it does not demand faith.

HENRY CAREY BAIRD.

Philadelphia, Dec. 20, 1862.

GENTLEMEN:—It gives me pleasure to state to you that, having noticed in your columns your intention to advance the price of the SCIENTIFIC AMERICAN, on and after Saturday the third day of January next, from \$2 to \$3 per year, if the price were even put at twice that sum, I for one should not discontinue subscribing for the same. I do not think that there is a journal in this or any other country that is so useful and beneficial to inventors and mechanics as the SCIENTIFIC AMERICAN. I have found its columns replete with matter in every way interesting and useful; and as a medium for bringing useful inventions before the public, I do unhesitatingly say that the SCIENTIFIC AMERICAN is equalled by no paper extant. Having advertised in 100 other papers at the same time that I have in yours, and with much more lengthy advertisements, I will give you the results, not for your especial benefit, but for those who may have improvements which they wish to disseminate throughout the land. The experiment to which I refer was continued only about four months; but during that time I received about three thousand communications from various parties residing in every State of the Union and its territories, from all parts of the Canadas, from England, France, Germany, Sweden, and even from Syria! Of this large number not over fifty of the communications were received from parties who apparently had read my advertisement in the columns of any of the other 100 papers; and of this fifty, many of them may have been from parties whose attention had been called to my advertisement in the SCIENTIFIC AMERICAN, inasmuch as many of them did not state in what paper they had noticed it. Even if the demand for my knitting machines did not fully come up with the supply, I should not have discontinued advertising in your journal; for funds thus spent have been to me like seed corn planted in well-tilled ground—it has yielded by a hundred fold a golden harvest. It hardly seems that Aladdin's lamp could have been more magical in its effect than the luminous columns of the SCIENTIFIC AMERICAN.

J. B. AIKEN.

Franklin, N. H., Dec. 22, 1862.

Great Men from Humble Life.

From the barber-shop rose Sir Richard Arkwright, the inventor of the spinning jenny and the founder of the cotton manufacture of Great Britain; Lord Tenterden, one of the most distinguished of English Lord Chief Justices; and Turner, the very greatest among landscape painters. No one knows to a certainty what Shakespeare was; but it is unquestionable that he sprang from a very humble rank. The common rank of day laborers has given us Brindley, the engineer; Cook, the navigator; and Burns, the poet. Masons and bricklayers can boast of Ben Johnson, who worked at the building of Lincoln's Inn, with a trowel in his hand and a book in his pocket; Edwards and Telford, the engineers; Hugh Miller, the geologist, and Allen Cunningham, the writer and sculptor; whilst among distinguished carpenters we find the names of Inigo Jones, the architect; Harrison, the chronometer maker; John Hunter, the physiologist; Romney and Opie, painters; Prof. Lee, the Orientalist, and John Gibson, the sculptor. From the weaver class have sprung Simpson, the mathematician; Bacon, the sculptor; the two Milners, Adam Walker, John Foster, Wilson, the ornithologist; Dr. Livingstone, the missionary traveler; and Tannahill, the poet. Shoemakers have given us Sturgeon, the electrician; Samuel Drow, the essayist; Gifford, the editor of the *Quarterly Review*; Bloomfield, the poet, and William Carey, the missionary; whilst Morrison, another laborious missionary, was a maker of shoelasts. Within the last year a profound naturalist has been discovered in the person of a shoemaker at Banff, named Thomas Edwards, who, while maintaining himself by his trade, has devoted his leisure to the study of natural science in all its branches; his researches in connection with the smaller crustacea having been rewarded by the discovery of a new species to which the name of *Franiza Edwardsii* has been given by naturalists.

Nor have the tailors been altogether undistinguished, Jackson, the painter, having worked at that trade until he reached manhood. But what is, perhaps, more remarkable, one of the most gallant of British seamen, Admiral Hobson, who broke the boom at Vigo in 1702, originally belonged to this calling. Cardinal Wolsey, De Foe, Akenside, and Kirk White, were the sons of butchers; Bunyan was a tinker, and Joseph Lancaster a basket-maker. Among the great names identified with the invention of the steam engine are those of Newcomen, Watt, and Stephenson; the first a blacksmith, the second a maker of mathematical instruments, and the third an engine fireman. Dr. Hutton, the geologist, and Bewick, the father of wood engraving, were coal miners. Dodsley was a footman, and Holcroft a groom. Buffin, the navigator, was a common seaman, and Sir Cloudesly Shovel a cabin-boy. Herschel played the oboe in a military band. Chantrey was a journeyman carver; Etty, a journeyman printer; and Sir Thomas Lawrence, the son of a tavern-keeper.

Michael Faraday, the son of a poor blacksmith, was in early life apprenticed to a book-binder, and worked at that trade until he reached his twenty-second year; he now occupies the very first rank as a philosopher, excelling even his master, Sir Humphrey Davy, in the art of lucidly expounding the most difficult and abstruse points in natural science. Not long ago, Sir Robert Murchison discovered at Thurso, in the far north of Scotland, a profound geologist, in the person of a baker there named Robert Dick. When Sir Robert called up at the bake-house, in which he baked and earned his bread, Dick delineated to him by means of flour upon a board, the geographical features and geological phenomena of his native county, pointing out the imperfections in the existing maps, which he had ascertained by traveling over the country in his leisure hours. On further inquiry, Sir Robert ascertained that the humble individual before him was not only a capital baker and geologist, but a first-rate botanist. "I found," said the Director-General of the Geographical Society, "to my great humiliation, that this baker knew infinitely more of botanical science, ay, ten times more than I did; and that there were only some twenty or thirty specimens of flowers which he had not collected. Some he had obtained as presents, some he had purchased; but the greater portion had been accumulated by his industry, in his native county of Caithness, and the specimens were all

arranged in the most beautiful order, with their scientific names affixed."—*Self-Help*, by Samuel Smiles.

[Had Mr. Smiles extended his remarks to the great men of other countries beside England he could have swelled his comments to volumes, because he could have included nearly all the greatest men of America. The object of Mr. Smiles is the presentation of examples to mechanics and men in humble circumstances of life, to aim high and strive for true honor and distinction in any walk of life to which they may aspire. The loftiest positions in literature, science, and art have been attained by men who have worked as tradesmen; and what has been achieved in past times may be accomplished again. At the present time, several of the living poets and literary men in great Britain and America were working tradesmen a few years ago. Gerald Massey was a factory spinner, John C. Prince a weaver, and A. Smith, author of "Life's Drama," a pattern-drawer.—Eds.]

Robert Stephenson and Electricity.

On another occasion he played a series of tricks of a somewhat different character. Like his father, he was very fond of reducing his scientific reading to practice; and after studying Franklin's description of the lightning experiment, he proceeded to expend his store of Saturday pennies in purchasing about half a mile of copper wire at a brazier's shop in Newcastle. Having prepared his kite, he sent it up in the field opposite his father's door, and bringing the wire, insulated by means of a few feet of silk cord, over the backs of some of Farmer Wigham's cows, he soon had them skipping about the field in all directions with their tails up. One day he had his kite flying at the cottage-door as his father's galloway was hanging by the bridle to the paling, waiting for the master to mount. Bringing the end of the wire just over the pony's crupper, so smart an electric shock was given it, that the brute was almost knocked down. At this juncture the father issued from the door, riding-whip in hand, and was witness to the scientific trick just played off upon his galloway. "Ah! you mischievous scoundrel!" cried he to the boy, who ran off. He inwardly chuckled with pride, nevertheless, at Robert's successful experiment.—*Lives of the Engineers*.

Balloon Barometer.

The barometer which was employed in testing the pressure of the atmosphere during the recent high balloon ascent in England, for scientific purposes, was made as follows:—A good tube, six feet in length, was selected, the mercury was boiled throughout its whole length; a cistern was blown at its lower end, which was furnished with a stopcock. These exactly equal portions of mercury were allowed to fall from the tube into the cistern, which was thus graduated. Then three feet of the tube was taken, and a scale applied to it, and which scale was then graduated from the lines on the cylinder. By this means a standard barometer was made of great accuracy, having also the advantages of being light and having the power of locking in the mercury in the tube when necessary.

Under Fire.

A French soldier, who first smelt gunpowder at the battle of Solferino, thus describes his sensations:—"How each shot electrifies you! It is like a whip on a racer's legs. The balls whistle past you, turn up the earth around, kill one, wound another, and you hardly notice them. You grow intoxicated, the smell of gunpowder mounts to your brain. The eye becomes bloodshot, and the look is fixed upon the enemy. There is something of all the passions in that terrible passion excited in a soldier by the sight of blood and the tumult of battle."

VEGETABLE OILS OF AUSTRALIA.—In Australia there are vast forests of trees which yield several varieties of essential oils. There is one large tree—the *Eucalyptus Amygdalina*—the leaves and twigs of which yield three pints of essential oil to each 100 pounds. Thirty-five different kinds of essential oils have been distilled from the trees of the Australian forests, and about 12,000,000 acres are covered with such trees. Some of them are aromatic and yield delightful perfumes. They are also solvents for various resins which are employed in making varnishes.

Improved Air Valve.

In working pumps, their operation is sometimes impeded by a portion of air which enters with the water or becomes separated from it; this is an evil of no small magnitude, as it prevents the formation of the necessary vacuum. The accompanying engraving is a representation of a simple but efficient invention for removing the difficulty alluded to. It is simply an ordinary brass cock, A, provided with a hemispherical top, in the upper face of which a series of small holes, b, are perforated; these holes are closed by an india-rubber valve, a—a portion of which is removed to disclose the apertures beneath. The cap, C, screws over the top of B, and protects the valve, while it also gives the invention a much neater appearance than it would otherwise have. The operation of the air cock is very simple. When the pump refuses to work, from the difficulty previously specified, the confined element—whether vapor or air—is readily discharged by turning the plug, D; the valve, a, then opens upward and permits it to escape; this operation can be repeated as often as desired until the cause of the trouble is removed. This appurtenance can be attached to any pump in a few moments, and will be found very useful; it can also be used as an oil cup by simply removing the valve.

Patented August 9, 1862, by Thomas Shaw. For further information address Philip S. Justice & Co. 54 Cliff street, New York city, or 21 North Fifth street, Philadelphia, Pa.

Elastic Breech Cannon and Sabot.

Numerous patents have recently been taken, both in this country and Europe, for devices to lessen the strain and liability of explosion in ordnance by the use of vulcanized india-rubber or gutta-percha applied in the breech to confine the air, against which the exploded powder will act, whereby the sides of the bore are relieved from the immense strain of the ignited charge. The objects of these inventions are to lessen the danger of explosion and enable the gun to give a greatly-increased velocity to the shot by using a larger charge of powder than is allowed or deemed safe in the old kind of guns. One of these inventions is that patented by Horace H. Day, the celebrated india-rubber manufacturer, of this city; another is that patented by Mitchell Ritner, of Vincennes, Ind., and a third is that patented by Col. J. W. Bird, of Trenton, N. J. Numerous experiments have been made with these devices, and we are informed that they were very satisfactory. Col. Bird's invention is a solid wad, made of india-rubber combined with fibrous substances; it is cut in disks to fit the bore of the gun, and is placed between the powder and the shot, and serves to rotate the latter. The elastic property of the rubber acting against the shot, it is claimed, gives it a perfect rotation, and at the same time it fills the space in the gun and prevents "windage." Much of the strain due to all wedge-shaped leaden rings, is avoided in Col. Bird's wad and projectile, and the inventor claims an increased power of at least one-tenth. The invention of Mr. Ritner is to confine air in sabots of vulcanized rubber, to be placed between the powder and shot, so that

the sudden concussion against the projectile is lessened by the yielding property of rubber and confined air, and enabling the artillerist to use a larger charge of powder, as previously stated. The object claimed to be gained is that which has long baffled the world of inventors—the use of a larger charge of powder

vention, it was found to be 69,000 lbs. The cushion has also been worked in a rifled 50-pounder with a charge of 8 lbs., from which the charge has been increased to 12 lbs., without any apparent evil effect on the gun; using shot of various sizes and weight, from 40 to 50 lbs. Two of the holes made in the target so long laying in Wall street, this city, were made by shot in connection with this elastic breech, fired with a 10-lb. charge from a rifled 50-lb gun.

This invention is readily adapted to any gun, and may be used in connection with all kinds of shot; it was patented by Mr. Horace H. Day, Dec. 2, 1862, and further information can be had by addressing him at New York city

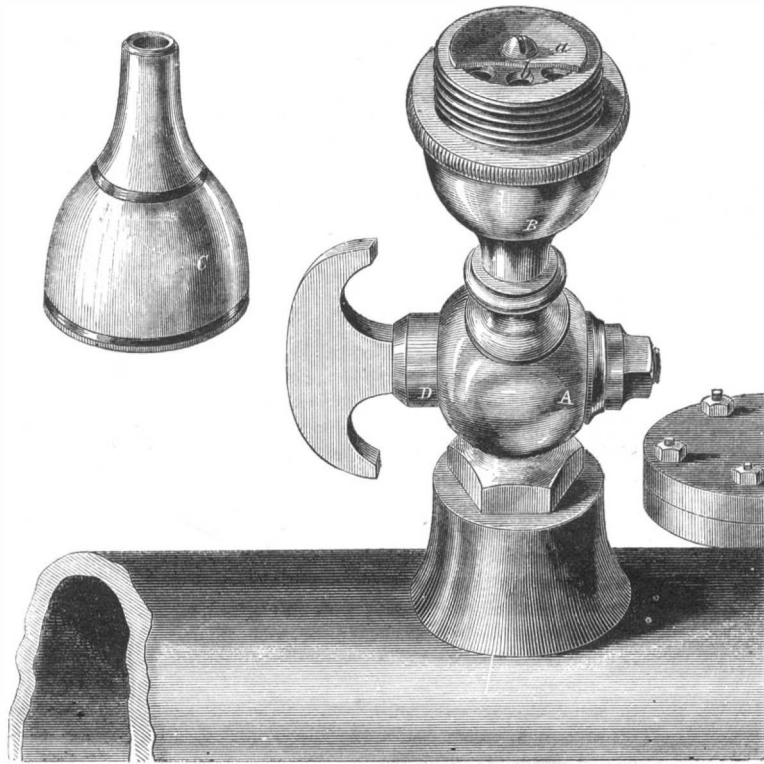
**SHAW'S AIR VALVE FOR PUMPS.**

without increasing the strain upon the gun. We here illustrate the last patent—that of Mr. Day. The tendency of the sudden blow imparted to the base of the missile, by the explosion of the powder, was to "upset" the base of the projectile by expansion, rendering it, if not immovable, at least dangerous to the gun. To overcome this, the inventor placed the hollow sabot between the powder and the shot. Mr. Day uses the india-rubber cushion, a, having a conical recess at its base. The charge is inserted upon the top of this, and another thinner disk, b, of the

1841, down to the present time, Mr. Timby has been engaged in perfecting his invention, and has spent large sums of money in so doing.

Modern Discoveries.

Bayard Taylor, the celebrated traveler, thus sums up the result of modern discoveries:—"Within the last twenty-five years, all the principal features of the geography of our own vast interior regions have been accurately determined; the great fields of Central Asia have been traveled in various directions from Bokhara and Oxus to the Chinese wall; the half-known river systems of South America have been explored and surveyed; the icy continent around the Southern pole has been discovered; the Northwest passage—the *ignis fatuus* of nearly two centuries has been at last found; the Dead Sea is stripped of its fabulous terrors; the source of the Niger is no longer a myth, and the sublime secret of the Nile is almost wrested from its keeping; the Mountains of the Moon, sought for 2,000 years, have been beheld by a Caucasian eye; an English steamer has ascended the Chadda to the frontiers of Bornou; Leichard and Stuart have penetrated the wilderness of Australia; the Russians have descended from Irkoutsk to the mouth of the Amoor; the antiquated walls of Chinese prejudice have been cracked and are fast tumbling down, and the canvas screens that surround Japan have been cut by the sharp edge of American enterprise. Such are the principal results of modern exploration. What quarter of a century, since the form of the earth and the boundaries of its land and water were known, can exhibit such a list of achievements?"

The first double hyacinth was obtained in the year 1710.

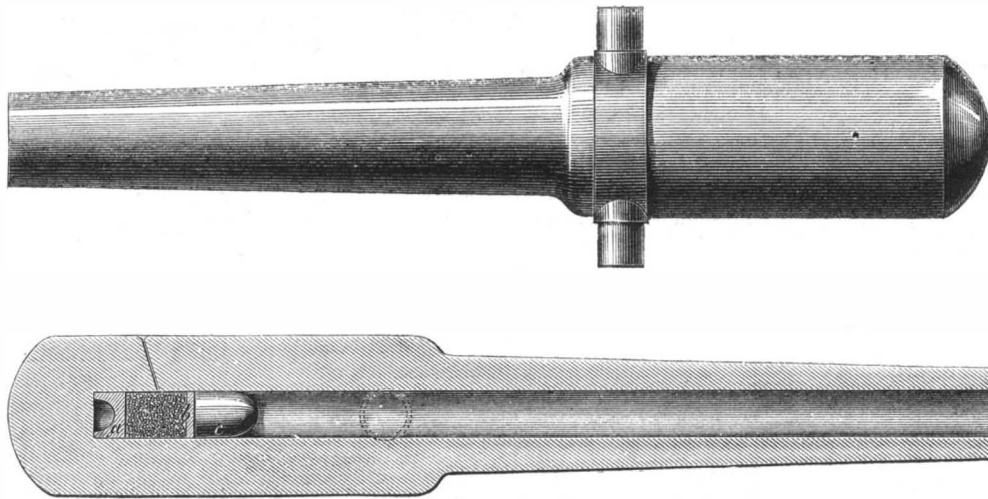
**DAY'S ELASTIC BREECH CANNON AND INDIA-RUBBER SABOT.**

same substance, is placed on top of it; the projectile, c, is then put in, and the weapon is fired in the usual manner. The cushion, a, is not destroyed by the explosion; and it is said one of them will last nearly as long as the piece itself; the thin wad, which obviates all liability of "windage," is of course fired out with the charge. The effect of the elastic cushion is to impart a gradual movement at the moment of explosion, which starts the bolt gently from its seat; the gases then follow it up and expel it with as much force as the powder is capable of exerting. The sabot has been tried (the inventor says) in a 100-pounder gun, and the strain at the breech was ascertained to be 48,000 lbs., while with the same gun and the same charge, namely, 10 lbs., without the use of this in-

The Scientific American.

MUNN & COMPANY, Editors and Proprietors.

PUBLISHED WEEKLY

At No. 37 Park Row (Park Building), New York.

O. D. MUNN, S. H. WALES, A. E. BEACH

TERMS—Three Dollars per annum—One Dollar in advance, for four months.
Single copies of the paper are on sale at the office of publication, and at all periodical stores in the United States and Canada.
Sampson Low, Son & Co., the American Booksellers, No. 47 Ludgate Hill, London, England, are the British Agents to receive subscriptions for the SCIENTIFIC AMERICAN.
See Prospectus on last page. No traveling agents employed.

VOL. VIII. NO. 2....[NEW SERIES.]....Nineteenth Year.

NEW YORK, SATURDAY, JANUARY 10, 1863.

TO OUR FRIENDS.

NOW IS THE TIME TO FORM CLUBS.

On Saturday, January 3d, a new volume of this journal commenced. We appeal to its friends in all sections of the country where mail facilities exist to endeavor to form clubs for the present year. We feel justified in asserting that no other journal in this country furnishes the same amount of useful reading, and especially at the extraordinarily low price at which it is furnished. The present high price of paper has rendered it necessary that we should somewhat increase the subscription price of the SCIENTIFIC AMERICAN, but by availing themselves of our clubbing rates persons may obtain the journal on very reasonable terms even now. We are obliged to pay more than double the price we did one year ago for the same quality of white paper that the SCIENTIFIC AMERICAN is printed on, while the subscription price to clubs is only a fraction more than formerly.

The long winter evening must be relieved of its dullness, and we must keep reading and thinking, and thus be prepared to overcome temporary difficulties and open new channels of wealth and prosperity. Friends, send in your clubs; at least renew your own subscriptions promptly.

ARCHITECTS—LIGHT AND VENTILATION.

The progress of discovery resembles the unrolling of a mighty scroll. Every age has witnessed new triumphs of mind over inanimate matter. Innumerable are the improvements which have been made in mechanism, but no improvements connected with the interests of humanity are of greater importance at present than those which relate to artificial light. The pine torch of the barbarian and the rush-light of an ignorant age have given place to incomparable gas light and beautiful argand lamps for burning the oil obtained from mysterious subterranean caverns. And yet, with all our numerous improvements, much has yet to be achieved before perfection is reached. Indeed, it is a fact that many improvements but serve to reveal imperfections which had previously escaped notice. It is the office of science to point out evils and defects, and to concentrate attention upon securing arrangements for their removal. Thus, upon another page will be found the communication of a correspondent respecting improved modes of lighting and beautifying a church in Albany, which affords us gratifying intelligence respecting a very proper enlargement of the architect's province and duties. In 1858, on page 125, Vol. XIV (old series) of the SCIENTIFIC AMERICAN, we pointed out the want of appliances in churches and other buildings for the removal of the poisonous gases emitted from open gas lights, and said:—"This is a question which deserves the attention of architects and others in regard to the erection of new buildings, all of which can be fitted up with the improvements suggested." Since that period such improvements have been carried out in several new public buildings in this country, and

it is pleasant to know that many architects are now taking a deep interest in such questions. They are generally men of scientific attainments and much intelligence, and it is right that they should embrace within the scope of their profession a far more extended application of science and art than the mere erection and decoration of buildings, chiefly with respect to what has been called "the legitimate principles of architecture." All buildings should be designed and erected with regard to the health and comfort of those who may occupy them temporarily or permanently, and provision should certainly be made in them for the removal of the foul gases arising from gas and other lights. Every person knows that the burning of an open charcoal fire in a room is dangerous to life, because the product of combustion is carbonic acid gas, which is as injurious to the human system, when inhaled by the lungs, as the taking of arsenic into the stomach. Now, as ten gas jets are equal to a moderately-sized fire in a stove for producing carbonic acid, it is not difficult to estimate the injurious effects of burning open gas jets in apartments. We regret that the suggestions referred to have as yet been acted upon in a very few cases, but the good work is begun, and all honor to the architects who have been the pioneers of the improvement.

Not only churches and other public buildings in which gas is burned should be arranged with provision for the removal of the subtle poison arising from burning gas, but dwelling houses also. Indeed, such appliances are more necessary for them than public buildings, such as churches, court rooms, &c., because persons in the former are constantly exposed to carbonic gas during evening hours, whereas in public buildings the exposure is only temporary. The application of such improvements is just as necessary in places where oil is consumed in lamps, as in those where gas is burned. Niches may be made in the walls of buildings to communicate with the atmosphere outside by valve tubes for carrying off the gas, and these recesses may be constructed with reflectors, and so formed as to be suitable for stationary lights and for receiving movable lamps. We trust that such improvements may soon be very generally applied, and thus unfold another cheering record on the scroll of progress.

THE WONDERS OF THE GLOBE.

From the creation of the world down to the present day, a series of organic changes has been constantly developed, which have not only altered in a material degree the outlines of continents and the land-marks of the mariner, but have changed greatly its constituent particles. For instance: the miners have delved in the bowels of the earth and withdrawn from thence thousands of tons of coal, which, in their turn, have been consumed and wasted by fire; their elements being so wholly transmogrified that nothing remains of all their bulk but a heap of dust. Through all these processes a gradual but constant diminution has gone on; the gases eliminated by the combustion of the fuel have been first set free, then ignited and finally resolved, as to their components, into the atmosphere. So also with the metals—precious and base; they, too, have parted with their individuality as earths, and have lost in bulk during the refinement to which they have been subjected. The rough and ragged edges of the ores have been smoothed into close and tenacious surfaces. The loose and striated masses have been knit closely, as to their fibers, until they are one and homogeneous throughout. Here, again, have the atoms comprising a whole parted, each one, with some portion of their identity whilst being transfused into one mass.

Not only do these changes occur in the metals and the minerals of the globe, but they also take place in the vegetable kingdom. The flowers of the field, the grass, the herbage; these wither and shrink before the fervent heat of the sun, and lose in weight and bulk. Nay! even the monarchs of the wood, unto whose roots the settler lays his civilizing ax, these come crashing down through their fellows and make the earth resound with the force of the impact. They also obey the dictates or the impulses of nature—they become green with mold, they rot to their cores, through all their sturdy branches the sap oozes out until they are utterly dead. Weigh the

dead tree and the living one, and tell us which is the more ponderable. Far to the north, among those huge icebergs, the formation of which no human eyes ever beheld, the cliffs that crop out in the polar regions waste slowly and silently away. Dr. Kane has told us that at their bases may be found, when not covered with snow, an impalpable dust; this is the debris of the rocks, cliffs, or whatever the nature of the structure may be. The silence of those regions is, at times, intense, if such an expression may be allowed. Except when the storms rage in their fury—when the grinding of those phantom towers against the loose pancake-ice ceases, when the floating floes circle idly in some eddy—then proceeds during the short northern summer the waste of the world. The tumuli of ice resolve to water; the monuments reared by the hand of the Frost King topple and fall; and, loosened by the genial warmth, streams trickle slowly down the rocks, carrying in their course the granulated particles liberated by the cold. In the dead of night, in the awful silence of those extreme latitudes, great masses of ice, or earth, or rock, loosen themselves and fall with a mighty crash into the sea beneath.

Thus, through all the zones that belt the globe—torrid, temperate and frigid—a continual waste, an incessant abstraction of the vital functions of nature transpires; these operations are both artificial and inevitable. How far do these organic and elementary changes affect the integrity of the sphere? Gases, as we well know, enter into the composition of our food, our bodies, and the very air and water that we breathe and drink. So also the cloud, silver-lined, that stretches its dark shadow over the summer or the winter heaven, surcharged with cooling showers or else with moisture which is changed in the atmosphere into star-like crystals of snow, these also hold in suspension some portion of the ethereal forces of the globe and descend to revivify and fertilize its various functions. The ashes of the coal part with their chemical ingredients, and make the grass green in the field, or drive the marauding worms from the crops of the farmer. The wasted form of the oak or ash is absorbed by nature, tenderly buried as it were, and enters once more into the shafts which tower above its resting place. So it is with all the material forces which have their being and which are rooted in the world. They arise or exist; they shoot from the soil or lie dormant within it; they are garnered, mined or burned; they vanish utterly in their natural forms, and are seen no more. Yet are they not lost. The several parts wanting are, as we have seen, absorbed by other plants completing their growth and ripening to maturity. In place of the coals that are consumed, there are other veins of them slowly gathering their forces for the comfort of millions yet to be. There are mines also accumulating those wonderful accretions which—now sullen and black, it may be covered by the restless sea—shall one day be exhumed and shine upon the brow of beauty. The globe parts with no portion of its matter to its ultimate loss; through all its vast lungs, the millions upon millions of pores in plants, the yawning ghastly craters of volcanoes, the fissures of the ground in various lands, the subtle vapors and essences from the vast laboratory of nature transpire. Yet all of them, as we have seen, are combined in some other form. The motion of the earth is no swifter than usual; in our headlong race around the sun, we come and go with as much regularity as ever; the stars move upon their nightly rounds, the moon appears and disappears, the planets circle in their orbits, and follow out the plan laid down for them by the Creator; and the vast and grand earth revolves rapidly through space, in obedience to the impulse which first gave it motion. Nothing changes to our loss. Man fights his petty battles, he slaughters those who cherished him, and he rises up in his weakness to mock at God and His works; but yet, through all and over all, the majestic operations of nature go forward with a certainty and surety that can only proceed from an origin and power beyond the knowledge of mankind.

A UNITED STATES TUN.—The Treasury Department has decided that the measure of a tun, in making assessments for the internal revenue, shall be two thousand two hundred and forty pounds, in all cases, under the excise law, unless the contrary is specified.

THE COMPARATIVE SOCIAL STANDING OF MECHANICS THROUGHOUT THE WORLD.

To the lover of his kind, to the philanthropist generally, few things in the wide range of social questions present a more interesting spectacle than the condition of the toilers and moilers who underlie the whole political systems of the world. The foundations of society rest, in a great measure, upon the mechanic arts. This is a broad assertion, and is supported by the following argument:—Although laws are framed for the guidance and protection of the community, these laws and enactments are of themselves, in our country at least, projected, carried out, and supported in force by members of the mechanical world at large. Take the working classes, that is, those who exist by manual labor, for they are in excess of the professional ones who live exclusively by their brains or those of others, and we shall find that the masses are represented by the followers of the several handicrafts; the hewers of wood and drawers of water form a noble army recruited from underneath all suns, gathered from every quarter of the globe, and exercising their several vocations alike in the torrid and the temperate zones. The comforts, the pre-eminence, the distinctions which are open to these men, the political privileges they may enjoy, their hopes, and the mundane prospects open to them, should excite no small part of our consideration. In a state of turbulence they excite the utmost alarm in any Government, but quietly fulfilling their destinies, rising with the sun and toiling long after the going down of the same, they accomplish and carry out the inevitable course of natural laws.

The well-being and, consequently, the tranquillity of this class of men depend upon several things; among these may be found the standard of wages, their social status, and their general intelligence. These material matters are, in their turn, dependent, as to the first issue, upon the demand for the workmen's services; as to the second, upon the particular form of government under which they live; and, lastly, upon the liberality of the State. A man who lives solely by selling his labor, will, in most instances, carry it to the market where it will command the best price. Various causes conspire against the consummation of this plan—such as the natural ties of locality, home attachments, or encumbrances of one sort or another, and these are providential so far as they restrict emigration. Were it not for these irrevocable laws the country that is especially favored in respect to the points mentioned would soon be overrun and reduced to a level with the others. Let this be taken as a solution of the question, why all countries are not alike, or why one is not as good as another, and we have, limitedly, the secret of superiority. As we have said, the capital of the workman is his hands and brain; and the country which pays him the most for the use of one and the development of the other is the one which he will select as the theater of his operations.

We make a distinction between the use of hands and the development of brain power, as the best means of conveying the idea of invention. Invention is the product of thought, and this thought originates in the brain; consequently, wherever there is the best field for invention—where the discoverer is the most fully protected in his rights—that, most assuredly, will be to him the promised land. Comparatively few workmen, in this age, are satisfied to jog contentedly along with the saw and the hammer as companions. No! this is the era of enlightenment and useful discovery. And as the incentives to mental action are great, viewed in the light of ordinary human aspiration, just so strong is the struggle to obtain the prize of wealth which it holds out.

Let us look at our own country to-day, or rather as it was before the broils of politicians had obscured all the fair landscape with the smoke and turmoil of battle, and threatened for a time to overthrow all law and order; let us see what our footing is in reference to the caption of our article. With us the workman is respected as an important member of society; in return for the years of his apprenticeship, he will receive, on an average, from \$450 to \$600 per annum. Not that a great many do not obtain more, but the rather that this is a fair average of the compensation received by all trades. This

sum, depleted by the holidays and necessary relaxation from toil which is demanded by the body, is all that he has to support his family and establish them in some decent occupation. The State cares for their education, and he need be only at the expense of maintenance. On his table the mechanic in our country can place all kinds of meat, also fish and poultry, if he be luxurious in his tastes; fruits, vegetables, flowers, these are all within the reach of his means, and can be indulged in limitedly. Thus far the inner man; what of the brain and its needs? In nearly every ward of the cities which spread themselves broadly over the land there are well-stocked schools and academies which will take not only the workman's children and make able scholars of them, but also himself in the evening, if his education has been neglected, and put at his disposal the primary branches of knowledge, which, once mastered, make all others comparatively easy.

Thus are the two great and most pressing wants provided for—the body and the brain. So also, if we look at the operations of the commercial transactions of the country and the bearing these have upon the mechanic's interests, we shall find so moderate a scale of prices in respect to food, clothing and the intellectual pleasures, that he may have not only enough to feed himself and little ones abundantly, but also find a surplus with which he may clothe himself like a gentleman, and visit the concert or theater as often as is necessary. Also, in the legislation of the land, his voice may be as loud and his influence as strong as any millionaire of the metropolis; he exercises his own judgment, and if oppressive or corrupt laws are put in force, it is the fault of the class to which he belongs. Nay! he may himself, enjoying the confidence of his fellow-citizens, aspire to any seat of power in the land. Few names shine more brightly on the roll of honorable distinction than those who were formerly heard of only in the workshops and mills.

From these observations we deduce the fact that America must be, of all places, the most desirable one for mechanics, and certainly, compared with other parts of the globe, it would appear so. Look for a moment upon the social standing of mechanics in the old countries—in England for instance. The mechanic in that kingdom is as widely different from his coadjutor here as the countries are distinctly separated by the sea which flows between them. It is true that there are institutes and places for public gatherings, where the artisan may listen to lectures and themes discussed by the most eminent of his profession; there are, moreover, protective societies, in which the compliance with certain fixed rules and the payment of a monthly subscription entitle the member to the support of his fellows, both morally and materially. With all these advantages, however, there is, in the English workman, a lack of the particular individuality which is so dear to the heart of the American artisan. Merge the latter in the mass, and you destroy his efficiency. Appeal to his personal skill and knowledge and you incite, not him alone, but the whole of his comrades, to act in such a manner that they also shall receive this coveted reward. The English form of government may be adduced as the reason for this. The aristocrats are so powerful that the laborers and petty tradesmen associate only with themselves, and are denied, generally, those opportunities of social cultivation which are here attainable; though it may be remarked that gentility, like poetry, is inborn and cannot be assumed. So also as regards the wages, the American workman has decidedly the advantage. English artisans with whom we have conversed, assure us, however, that the average amount of wages received per week by them is about thirty shillings, or \$7.50 of our money. Now, if these figures are correct, we cannot think that the prices of food are so vastly less abroad than they are with us; for, at the same scale of prices, even, the mechanic here would have much the advantage of his brother in Europe. At all events those mechanics who come to this country will not compare favorably with the mass here.

Throughout Europe the case is much the same; the Government is the controlling power, for or against the workman, and allows him just such privileges as it pleases. If we look at France, we shall find the wine-shops and cabarets full of police, who, clothed in the dress of honest citizens, listen

to conversations and ingratiate themselves into the confidence of groups, in order to find out the topics discussed. By such means the Government is always informed of the tranquillity or restlessness of the so-called lower classes. In Austria it is the same, and as well in Italy and some other of the smaller principalities that border on the Danube. In Germany the workman is free, comparatively; he goes to his beer-shop, sings, dances—does, in short, what he will, so that he only keep out of mischief. In all of these aspects of mechanic life we see features that are exclusively national and which enable the proficient to recognize artisans of different nationalities at a glance wherever they are met. The British mechanic is apt to be lowering, beery and sulky; but he is steady when at work, a skillful man, generally, in the details of his business, and thorough. The Frenchman is gay, vivacious, and volatile to a fault; he is often found over his *vin ordinaire*, and is an enthusiast in his profession, but not by any means so thorough as his neighbor across the Channel. So also the German; his traits are sluggishness, a general-tobacco-and-lager halo surrounding him, and a heavy lumpy way of working, which is in strong contrast with the others previously mentioned; these qualities act against the production of any very fine mechanical work; in general, German wares are coarse and heavy. If we look at the American mechanic we shall find a combination of all the qualities above cited. He is energetic, enthusiastic and full of ways and means to overcome special difficulties. His disposition is to hurry through with his business as fast as possible. Time is money with him, and a deal of it, too; he consequently urges his powers to their fullest extent. It would seem that the attention of the mechanic in this country is given chiefly to invention, so many are there brought forth, and this can be accounted for by the value of the patents. Many and many a handsome fortune owes its existence to the well-directed efforts of a few hours' thought. The number of discoveries of this kind multiply every year in all branches of art, science and manufacture, and we hold to-day, as we have always held, the reputation of being the most ingenious people on the globe.

Much more time and thought could be profitably employed upon the subject of this article than it is in our power to bestow; it is one full of interest, and we hope from time to time to say a few words upon our progress in the mechanic arts, as also upon the superior intelligence and mental qualities generally of our American mechanics.

HOMES FOR MEN OF MODERATE INCOMES.

There are some peculiar phases of city life which present food for thought, and afford opportunities for observation which, if properly improved, cannot fail to be of service to a vast majority of our citizens. In our last volume we presented our readers with some statistics concerning the cost of living, or, rather, of the bare support of life; "living" being a general term, which includes many things besides the mere staff of life. Let us now look at the manner in which families are obliged to live with reference to their apartments. It is a well-known fact that, owing to the value of real estate, and the enormous taxes with which property-holders are saddled, rents are high and the accommodation given therefor correspondingly limited. It is by no means uncommon to pay \$1,000 or \$1,200 per year for the use of a house whose surroundings, in the way of neighbors and the streets adjoining, are very far from being desirable. As we descend in the scale of prices, we shall find dwellings in the heart of the poorer quarters, on the eastern side of the city, which are rented to many families—say from four to forty, and in some cases to still greater numbers (these figures do not designate individuals, they represent families); from the curbstone to the garret every room is thickly crowded with human beings. Such tenements are rented in suites of separate apartments, for which a monthly rent is exacted, varying with the distance from the street, those nearest the sky being of course the cheapest. The average receipts for one of these tenements will amount to the astonishing sum of \$600 or \$800 per annum. This in houses which are not by any means worth ten times those sums; indeed, we are told by those who ought to know—the landlords—that fifteen per cent is not at all an un-

common return for the capital invested. In some of the retired streets of the city, further up town, the rents are less, but those which border on the business parts command prices correspondingly great. Having now obtained a sliding scale of rents from \$1,200 to \$600, let us look at the means which people generally have to pay for such accommodations. It is safe to assume that one cannot, as a general rule, pay more than one-sixth of their income for house rent; if any one does this, with a family always in the back ground relying on him for maintenance, they must, in order to pay the first-named sum, have an income of at least \$6,000 per annum. Now, as that sort of salary is, unfortunately, remarkably scarce at the present time, we had better leave this part of our subject and come down immediately to more rational sums; say, for instance, from \$600 to \$1,500 per annum. There are many modifications of this question which ought to be considered before going farther, which we are not able to discuss; and these questions may be embraced in the natures of the professions which occupy our citizens, and the requirements of them, as regards houseroom, rent, &c. For example, the mechanic, whose employment is exclusively laborious; he does not require, although his taste may exact it, so much of elegance or decoration as the man whose calling is intellectual, and who depends in a great degree for his mental culture and sustenance upon the material matters with which he comes in daily contact. These things being self-evident, we shall not pursue them further.

Taking up the amount of our incomes again, we find that for one of \$1,000 we shall have, if it is divided by one-sixth, about \$167 with which to satisfy the landlord. Now let any one look at the apartments, not-houses; which are to rent for these prices, and it will be seen that they are wholly unfit for civilized habitation. Not only are they full of dark holes of bedrooms, where one stifles in the summer, but they abound in vermin, and are uncleanly to the last degree. Something different is required, and that is, houses constructed on principles wholly at variance with those just mentioned. This suggestion is not at all difficult to carry out. There should be buildings put up with reference to the wants of gentlemen with small incomes. A man with a limited purse may often have as much, or more, refinement than he who reckons his dollars by thousands, and it is in behalf of a large class—by far the majority—of our citizens, that we raise our voice on this subject. If tenement-houses can be erected and made to pay a sure dividend, that is the rent in advance, of 15 per cent, certainly dwelling-houses of the new style can be run so as to amply remunerate their owners, even with the present rates of taxes. The buildings to which we have reference should embrace conveniences on one floor for satisfying all the actual wants which arise in daily life; as, for instance, the elevation of coals from the cellar, the conveying away of slops, in short, the many conveniences which modern machinery substitutes for muscle. Strict privacy should also be guaranteed to every dweller within the walls. We venture to assert that if such dwellings were erected, they would not only be full the year round, but command better rents than the miserable holes which are now the only refuge of hundreds of families in this city. New York life differs materially from that of towns and cities elsewhere in the States, and to meet the character of it we should have suitable homes to retire to at the close of the day. Nothing has a greater or more beneficial effect upon society generally than the observance of those usages and amenities which are alike the distinguishing features of civilization and Christianity.

DONALD MCKAY ON THE FRENCH NAVY.

Donald McKay, who is now in Paris, has just communicated to the *Commercial Bulletin* (Boston) a very interesting account of the condition and size of the French navy. According to the heading of the communication "France is Mistress of the Seas"—a statement not quite warranted by the facts given. The transformation of the French navy to armor-clad vessels commenced in 1855, and it will be completed in 1870, when it will consist of forty first-class iron-cased frigates, with armaments varying from 36 to 52 guns each (all rifled and breach-load-

ing), having engines of from 900 to 1,200 horse power, and all possessing a speed exceeding twelve knots per hour. The naval estimate for 1863 amounts to 143,418,920 francs—nearly \$30,000,000. The steam navy of France at present is composed of 325 vessels of all classes, and there are forty-two building. There are six iron-cased frigates afloat, and ten building; and there are fourteen iron-plated batteries afloat and seven building; and there are 119 sailing vessels belonging to the navy. Mr. McKay states that, of the sixteen iron-cased frigates afloat and in the course of construction, only two are entirely of iron; and he says:—"It is now regretted by the Government that these two were not constructed of wood, for experience has already proved, and without any contradiction, that these vessels, on account of their bottoms fouling rapidly, will not be capable of keeping up in speed with the wooden-built and coppered frigates. The *Warrior*, of the English fleet, has lost from this cause two knots of her original speed, and it is generally conceded that these iron-built men-of-war ships will have to be taken into dock at least every three months, to clean their bottoms." Mr. McKay alludes to the speed of the pirate *Alabama* exceeding that of any vessel in the American navy, and she is wooden-built and copper-bottomed. In our opinion these views of McKay should be modified.

It is indeed true that the bottoms of iron vessels become foul, and thus far no paint or cement used for coating them has prevented the adherence of barnacles; but the evil is not so great as has been represented, else why should the mercantile classes of Great Britain prefer them to all others? Merchants are shrewd business-men; they look more to profit and loss than Governments, and if the expenses of maintaining iron vessels were so great as has been alleged, of course merchants would prefer wooden steamers. But it is a fact that not only the English, but the French and German ship-owners have discarded wooden steamers, and have superseded them with iron screw-steamers.

The thickness of iron casing in the French frigates afloat, as well as those on the stocks, is four and three-quarter inches near the load line, and four and three-eighths above. *La Gloire*, *Invincible* and *Normandie* are simply timber-built vessels cased with iron. They have attained a speed of thirteen and a quarter knots per hour under steam alone, with men and armament on board. They roll easily, are tight, steer well, and are efficient fighting ships. The ten new iron-clad frigates on the stocks are similar to *La Gloire* in outline, but they will carry their battery fourteen inches higher. Their dimensions are, length, 265 feet; breadth, 56 feet; mean draft, 25½ feet. The iron-cased frigate, *Normandie*, has made the voyage across the Atlantic and is now at Vera Cruz. She has proved to be a good sea-vessel.

Several private establishments in France are filling orders for the Government. M. Arman, at Bordeaux, is building two iron-cased floating batteries. They are to be covered with six-inch plates, and armed with 180-pounder steel guns. At Nantes, M. Gouin is building two similar batteries, but their plates are only four and three-quarter inches in thickness. The whole dockyard organization in France is very perfect, and arrangements were lately made at Toulon and Cherbourg whereby provisions, &c., could be put on board of a fleet in half a day for an army of 60,000 men. All the naval constructors in the French service are allowed to submit their plans to a commission, and the plan offering the most advantages, though perhaps coming from the lowest rank, is accepted. Mr. McKay recommends this excellent system to our Government. He asserts, that in comparison with the French and English navies that of America is not worthy of the name, and he recommends that twelve first-class iron-cased frigates be commenced without delay. He also recommends that no iron ships be built, but woodenships covered with plating. He says:—"Iron ships ought not to be adopted in our sea-going fleet, for the following reasons:—

"1. The fouling of their bottoms (against which no remedy has been found yet) and consequent loss of speed.

"2. The weakness of their bottoms, and consequent liability of soon breaking up whenever they touch.

"3. The impossibility to give them a good ventilation, all the artificial means having failed to produce

a good ventilation on account of the many water-tight bulkheads necessarily used in their construction.

"4. Their great unhealthiness, as proved already by the few cruises made by the *Warrior* and *Defence*."

The second reason against iron vessels advanced by Mr. McKay, has been proven to be groundless. However, wooden vessels covered with armor may be the best for us to adopt. It should not be forgotten however, that the English entire iron frigates, so called, are composed of wood and iron. The framing, inner lining, and armor are iron; the middle casing is thick teak planking. In all likelihood the French large breach-loading navy guns will prove very inferior, like the Armstrongs, to muzzle-loading guns. Mr. McKay has heard that several large frigates of over seven thousand tons are to be constructed for our navy. He regrets this, because he considers them unsuited to the shoal waters of most of our ports.

SCREW-CUTTING LATHES.

When threads are cut with tools, in lathes, they are, provided the leading screw is a good one, more accurate than those made by dies. They require, however, much more time than the latter tools; this matter can and should be remedied. Lathe-makers seem to think that in providing changes of gear they fulfill all the requirements of the tool for this special purpose. In reality, many more appurtenances are necessary—guides, steadiments, doctors, side screws on the rest to gage the depth of the thread, &c. These might all be furnished, and a lathe turned out, for the avowed purpose of cutting screws and for doing nothing else, just as milling machines are made which will execute any curvature or angle desired in iron, brass, or any other metal. So also for cutting up nuts, there should be an attachment, by gearing or otherwise, that would cause the rest to travel back and forth like a planing machine bed; all the workman would have to do, in this case, would be to run the tool in or out, as the motion changed; he would then be sure of hitting the thread every time. In fractional threads and with old lathes this is sometimes a matter of difficulty. Here are suggestions which we think would, if followed up, result in the production of a lathe which would be highly popular with manufacturers.

AN IMPORTANT FACT.

A recent editorial article in *Mitchell's Steam Shipping Journal* (published at Liverpool, England,) contains the following item of information, relative to some peculiarities which it has discovered in our harbor; these will doubtless be highly appreciated, if not heeded, by mariners generally. Speaking of the *Great Eastern*, it says:—"In the Thames she grounded at low water, but in New York, where she anchored, there is no tide, and the River Hudson keeps up a continuous flow of water." We have carefully examined the remainder of the article from which the extract is taken, in the hope of being able to find some explanation of the statement that the Hudson keeps up "a continuous flow of water," and that we have no tide here; but being unable to discover any thing bearing on these points we have reluctantly given up the search. We would like to inquire of our astute cotemporary if there are in England any rivers that operate on the "palpitation" principle? All the rivers in this country, so far as we know, keep up "a continuous flow of water." Whenever they fail to do this we look upon them as mere mud-holes—something like the Thames at low tide.

SEVENTEEN THOUSAND PATENTS SECURED THROUGH OUR AGENCY.

The publishers of this paper have been engaged in procuring patents for the past seventeen years, during which time they have acted as Attorneys for more than SEVENTEEN THOUSAND patentees. Nearly all the patents taken by American citizens in FOREIGN countries are procured through the agency of this office.

Pamphlets of instructions as to the best mode of obtaining patents in this and all foreign countries are furnished free on application.

For further particulars as to what can be done for inventors at this office, see advertisement on another page, or address

MUNN & Co.,
No. 37 Park Row, New York.

RECENT AMERICAN INVENTIONS.

The following are some of the most important improvements for which Letters Patent were issued from the United States Patent Office last week. The claims may be found in the official list.

Uniform Scale.—The object of this invention is an improvement on that class of scales for which Letters Patent were granted to the same party on May 24, 1859, and the invention consists in the employment of bell-crank levers in combination with and connected to each other and to double knife-edged pendent levers and to a graduated scale beam, in such a manner that, by the action of said bell-crank levers the oscillating motion of the pendent levers is transmitted to the scale beam perfectly correct and by means which are cheap and easily put up, and which, when put up, are durable, not liable to get out of order and work with as little friction as possible either up or down, rendering these scales equally applicable for weighing railroad cars, &c., and also for weigh locks. Elnathan Sampson, of Waterford Junction, N. Y., is the inventor of this improvement, and he has assigned his full right to the Sampson & Tibbet Scale Company, 15 Dey street, New York city.

Projectile for Ordnance.—This invention relates to projectiles which are intended to be fired from a gun having a bore of larger diameter than their own, for the purpose of concentrating, within the smaller transverse sectional area of the projectile, all the force obtained by the pressure of the gases of the gunpowder on the larger transverse sectional area of the bore; and it consists in a jacket or case of a novel character applied to and combined with such a projectile in such a manner as to center it in the bore of the gun, to leave the gun with it, and to remain attached to it during its flight, and only to be detached by the act of the projectile striking and after having added its momentum to the impact of the projectile. The inventor of this projectile is W. H. Smith, of Birmingham, Conn.

Combination of Melodeon and Pianoforte.—The object of this invention is to combine a reed musical instrument, such as is known as a melodeon or harmonium, with a pianoforte, in the same case, with a separate and distinct set of keys for each, so that each can be played separately or the one as an accompaniment to the other by a different player, without making the said case much larger or very perceptibly altering its appearance in any way; to this end it consists in the arrangement of the reed-board within one end of the case in an upright position, and the arrangement of the key-board to swing back into the case with the keys nearly close to the reed-board when it is not desired to play upon the reeds; also in a novel arrangement of the action in combination with such arrangement of the reeds and the key-board. R. W. Carpenter, of Brooklyn, N. Y., is the inventor of this device.

Rules to be Observed while Skating.

The following excellent advice, taken from *Hall's Journal of Health*, will doubtless be appreciated, if not followed, by many of our readers at this season:—

Skating is one of the most exhilarating of all pastimes, whether on the ice, or over our parlors or hall floors, with roller skates. In the days of "Queen Bess," some three hundred years ago, it was a favorite amusement with the Londoners, whose facilities for the same were limited to pieces of bone attached to the shoes. As lives have been lost in connection with skating, the following suggestions are made:—

1. Avoid skates which are strapped on the feet, as they prevent the circulation, and the foot becomes frozen before the skater is aware of it, because the tight strapping benumbs the foot and deprives it of feeling. A young lady at Boston lost a foot in this way; another in New York her life, by endeavoring to thaw her feet in warm water, after taking off her skates. The safest kind are those which receive the fore part of the foot in a kind of toe, and stout leather around the heel, buckling in front of the ankle only, thus keeping the heel in place without spikes or screws, and aiding greatly in supporting the ankle.

2. It is not the object so much to skate fast as to skate gracefully; and this is sooner and more easily

learned by skating with deliberation; while it prevents overheating, and diminishes the chances of taking cold by cooling off too soon afterward.

3. If the wind is blowing, a veil should be worn over the face, at least of ladies and children; otherwise, fatal inflammation of the lungs, "pneumonia," may take place.

4. Do not sit down to rest a single half minute; nor stand still, if there is any wind; nor stop a moment after the skates are taken off; but walk about, so as to restore the circulation about the feet and toes, and to prevent being chilled.

5. It is safer to walk home than to ride; the latter is almost certain to give a cold.

7. Never carry anything in the mouth while skating, nor any hard substance in the hand; nor throw anything on the ice; none but a careless, reckless ignoramus, would thus endanger a fellow-skater a fall.

7. If the thermometer is below thirty, and the wind is blowing, no lady or child should be skating.

8. Always keep your eyes about you, looking ahead and upward, not on the ice, that you may not run against some lady, child, or learner.

9. Arrange to have an extra garment, thick and heavy, to throw over your shoulders, the moment you cease skating, and then walk home, or at least half a mile, with your mouth closed, so that the lungs may not be quickly chilled, by the cold air dashing upon them, through the open mouth; if it passes through the nose and head, it is warmed before it gets to the lungs.

10. It would be a safe rule for no lady or child to be on skates more than an hour at a time.

11. The grace, exercise, and healthfulness of skating on the ice can be had, without any of its dangers, by the use of skates with rollers attached, on common floors; better, however, if the latter are covered with oil-cloth.

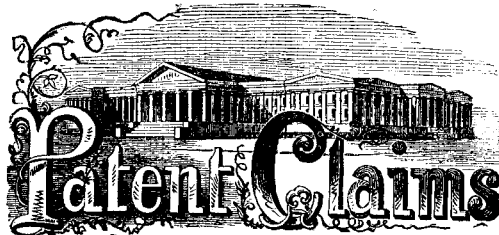

ISSUED FROM THE UNITED STATES PATENT OFFICE
FOR THE WEEK ENDING DECEMBER 23, 1862.

Reported Officially for the Scientific American.

* * Pamphlets giving full particulars of the mode of applying for patents, under the new law which went into force March 2, 1861, specifying size of model required, and much other information useful to inventors, may be had gratis by addressing MUNN & CO., Publishers of the SCIENTIFIC AMERICAN, New York.

37,209.—Lock.—John Adt, Waterbury, Conn.:

I claim the catch, C, when used in combination with the bolt, B, and the double-pronged bit, q, all arranged as herein set forth.

[This invention relates to an improvement in that class of locks which are constructed and arranged in such a manner as to admit of being readily inserted in an auger-hole made in a door, without the trouble of mortising. The object of this invention is to render the class of locks more compact and simple than any hitherto devised.]

37,210.—Bed Bottom.—Hiram Barber, Juneau, Wis.:

I claim the combination and arrangement of the springs, A, cross-bars, O, slats, G and F, and sheath, E, with or without the devices for raising and lowering the slats, F, substantially as and for the purpose specified.

37,211.—Metallic and Wooden Roof.—E. U. Benedict, Chicago, Ill.:

I claim the combination of gutters made of metal and substantially as described, with the joints and enlarged grooves of the board roof, the gutters being capable of being withdrawn, and the boards capable of shrinking or swelling independent of the gutters, all substantially as and for the purposes set forth.

37,212.—Lamp Insulator.—Alfred Bliss, New Rochelle, N. Y.:

I claim an insulating collar of gutta-percha or india-rubber, constructed with an internal thread, b, to receive the burner, A, and an external thread, a', to screw into the socket, B, substantially as herein shown and described, and adapted to entirely prevent contact between the metallic surfaces of the lamp top and socket, as explained.

[This improved form of insulator is adapted to entirely prevent contact between the burner and the reservoir, and may be applied by any one to lamps in common use.]

37,213.—Valve for Water Closets.—J. E. Boyle, Brooklyn, N. Y., assignor to James Stevenson, New York City:

I claim the hollow valve stem with its lateral induction and education water-ways, substantially as described, in combination with the induction valve, sliding piston and cylinder, provided with a small aperture or leak, to control the closing of the valve, and the diaphragm or the equivalent thereof, for closing the valve by the pressure of the water alone, substantially as and for the purpose specified.

37,214.—Churn.—Jacob Brinkerhoff, Auburn, N. Y.:

I claim, first, The hollow stud shaft, c', short metal shaft, b', key, d', and fly or balance wheel, D, when combined and arranged to operate in the manner and for the purpose specified.

Second, The series of longitudinally-grooved blades, H, in combination with the horizontal shaft, C, on which they are arranged in spiral lines, to operate in the manner and for the purpose set forth.

[The nature of this invention consists in a peculiar manner of hanging a balance wheel, whereby its entire weight is supported independ-

ently of the driving shaft on which it acts, relieving the latter of all strain except what is required to rotate the wheel, thereby lessening the tendency of the churn to leak by the bearing nearest the wheel wearing away more than the other. It also consists in a peculiar construction of the dasher, whereby it is made more effective in its operation both in the formation and gathering of the butter.]

37,215.—Elevator Bucket.—J. E. Brooks, Rochester, N. Y.:

I claim the employment of a shield or facing of steel, or its equivalent, in any hardened metal, to elevate buckets, as and for the purposes described.

I also claim, in combination with the above, the mode of putting the iron band around the back and ends while they are flat, and fastening it to the steel facing, as and for the purposes shown and described.

37,216.—Cartridge Box.—Francis Bush, Boston, Mass.:

I claim, first, The adjustable inner box or boxes, B, in combination with the box or case, A, in the manner and for the purpose specified. Second, In combination with the boxes, A and B, the employment of a stop, substantially as and for the purpose described.

37,217.—Combination of Reed Instruments with the Pianoforte.—R. W. Carpenter, Brooklyn, N. Y.:

I claim, first, The arrangement of the reed-board, C, and the key-board, D, in combination with each other and with the extended portion, B, of the case, A, B, substantially as and for the purposes herein described.

Second, In combination with such arrangement of the reed-board and key-board within the case, I claim the combination of the reeds and keys by means of jacks, G, G, applied substantially as herein specified, to permit the closing-up of the key-board.

37,218.—Bucket for Chain Pumps.—J. D. Clark, Leicester, Mass.:

I claim a grooved bucket in combination with an elastic packing ring, as herein described, and for the purpose set forth.

37,219.—Cultivator.—Josephus Danner, of Milton, Ill.:

I claim the combination and arrangement of the draught pole, A, the adjustable beams, B, the standards, C, and shares, c, the supports, D, and the bar, E, and the strap, F, or its equivalent, all arranged and constructed substantially as and for the purposes delineated and set forth.

37,220.—Coal-oil Burner for Lamps.—Joseph Dodin, Brooklyn, N. Y.:

I claim, first, The particular shape of the plate, Fig. 4, with its slots, a, substantially as described.

Second, The circular plate, Fig. 5, with its slot, M, in combination with the moveable tube, Fig. 3.

37,221.—Can or Bottle Stopper.—Jacob Dunton, Philadelphia, Pa.:

I claim a bottle or can stopper consisting of the socket, A, formed with a milled head, B, external screw thread, a, and internal shoulder, a', the neck, D, formed with an external lip, G, internal screw thread, d, and annular flange, E, and the imperforate cylindrical cock or plug, C, all constructed, combined and arranged in the manner and for the purposes shown and described.

[This improved stopper has been extensively introduced in the army and is found well adapted for medical and other uses.]

37,222.—Bayonet Scabbard and Guard.—John G. Ernst, York, Pa.:

I claim, first, The ring, D, adapted and employed to operate in combination with the scabbard, C, and guard or scabbard, A, in the manner and for the purposes specified.

Second, The combination of the guard ball, E, with scabbard, A, to constitute a combined scabbard and guard, as explained.

[A description of this invention will be found on page 200, Vol. VII (new series) of the SCIENTIFIC AMERICAN.]

37,223.—Loom.—John F. Fosdick, Lowell, Mass.:

I claim my improved application and arrangement, as described, of the guide, a, the take-up roller, b, the bearing roller, c, and its guides, d, with respect to the lay and the breast beam of the loom.

37,224.—Churn.—Herman Gardiner, New York City:

I claim, first, The secondary chamber, C, at the bottom of the churn, closed as described, having the apertures for the ingress and egress of the milk, in which the agitating and permeating process is produced, separate from the milk in the body of the churn. Second, The combination and arrangement of the chamber, C, the cylinders or tubes, D E E', around the dasher, operating so as to maintain, when the dasher is in motion, a circulation and agitation of the milk and air, as described.

Third, The use and application of the combined gauze cylinder, E, and sliding cylinder, E', for regulating the circulation of the milk while the process of churning is going on.

Fourth, The combination and arrangement of the inner tube, D, and outer tubes, E E', so as to form the hollow space or chamber through which space the milk is drawn downward to the bottom of the churn into the chamber, C.

37,225.—Attaching Handles to Cutlery.—J. W. Gardner, Shelburne Falls, Mass.:

I claim forming handles for cutlery and implements pertaining or analogous thereto, by means of the parts, C C, secured to a flat tang, B, by means of ferrules, D D, fitted and compressed in recesses, a b, made respectively in said parts and the tang, substantially as herein set forth.

[This invention consists in having the implement provided with a flat tang, and the handle formed of two parts placed one at each side of the tang and secured thereto by means of ferrules.]

37,226.—Washing Machine.—M. L. Grover, Duplainville, Wis.:

I claim the combination of the clothes receptacle, B, and rubber, E, constructed and arranged as shown, and used in connection with the suds-box, A, for the purpose specified.

[This invention relates to an improvement in that class of clothes-machines in which a rotary or a reciprocating partially-rotating clothes-cylinder is employed and fitted within a suitable suds-box. The invention consists in the employment or use of a cylindrical clothes receptacle formed of staves or slats with open spaces between them to admit the suds, said staves or slats being grooved or fluted at their inner surfaces, and the clothes-receptacle having a rubber suspended within it, constructed and arranged in a novel way.]

37,227.—Hold-back for Carriages.—H. A. Harris, Battle Creek, Mich.:

I claim the use of a graduated bar in combination with a moveable stirrup or ring and a spring, for the purpose and substantially as set forth.

37,228.—Heater.—J. C. Henderson, Albany, N. Y.:

I claim, first, The range of vertical hot-air pipes, h, h, within the cylinder, d, in combination with the cone, k, that deflects the products of combustion against the base of said pipes and cylinder for the purposes and as specified.

Second, I claim the conical chamber, k, in combination with the cylinder, d, and air pipes, m, m, as and for the purposes specified.

37,229.—Adjustable Link.—Jonas Hinkley, Norwalk, Ohio:

I claim having the sides of the two links pivoted together as shown, with an opening in each link just in front of the pivot, all as herein set forth.

[The object of this invention is to obtain a link of simple construction which may, in the case of the breaking or parting of a chain serve as a means to cement the same and be capable of being very readily adjusted in proper position, and also capable of being detached with facility, and, at the same time, not be liable to become casually detached. The invention is more especially designed for a temporary fastening to be carried by teamsters and others, for the purpose of connecting a broken chain until it can be properly repaired by a smith.]

37,230.—Governor.—J. S. Howell, Portsmouth, N. H.:

I claim the friction strap or box, j, on the nut, f, in combination

with the stop, h, h, on the screw, substantially as described for the purposes set forth.

37,231.—Treating Caoutchouc.—Liverus Hull, Charlestown, Mass. :
I claim the application of carbon spirits, as described, and chloride of sulphur, to ground caoutchouc, substantially as and for the improvement of it, as specified.

37,232.—Floating Battery for Ships and other Navigable Vessels.—James Hyde (assignor to Thomas Keech), New York City :

I claim, first, The employment of a floating turret in combination with a floating tank or ship's hull, substantially in the manner and for the purposes hereinbefore described.
Second, I also claim forming a communication between the interior of the ship, A, and inside of the floating turret, D, through the frame, B, and hollow shaft, F, substantially as and for the purpose set forth.

37,233.—Boot and Shoe.—Oliver Lafreniere, New York City :

I claim a boot or shoe provided with a dovetailed plate, D, grooved heel frame, E, and sole frame, A, all made and united in the manner herein shown and described.

[The object of this invention is to produce cheap, durable and easy boots or shoes, and the invention consists in the employment, for the purpose of soling boots and shoes, of a metallic frame filled with hard wood or some other suitable material, and secured to the inner side of the boot or shoe by means of screws or rivets, or by any other suitable means, in such a manner that the sole can be made cheap and attached in a short time with little trouble, and that it will wear much longer than soles of the ordinary make.]

37,234.—Harrow.—John Kelsey, of Yardleyville, Pa. :

I claim the construction of the oblique extended point, B, with its front tooth, C, and the scraper, M, when arranged and combined with the harrow, as herein described and for the purposes herein set forth.

37,235.—Engraving Machine.—J. S. Ives, of Morrisania, N. Y. :

I claim the employment of a shaft or rod, K, hung by a universal joint in an adjustable stand, F, in combination with a table, D, or its equivalent, connected by a universal joint to one end of rod, K, and a tracer or engraving tool, e, the whole operating substantially as set forth, to produce on a surface placed on table, D, various designs from patterns which guide the lower end of rod, K, in the manner hereinbefore described.

I also claim making the pivots, or their equivalents, of the universal joint in stand, F, adjustable or variable, substantially as described, for the purpose of changing the proportions of the designs cut from the same pattern.

I also claim the construction of the machine substantially as described, so as to admit of changing the angles of the axes of the universal joint, for the purpose of inclining the design in either direction to its base, while the pattern has no inclination, as hereinbefore described.

I also claim the sliding rod, k, in combination with the rod, K, and a suitable handle, i, substantially as and for the purposes described.

37,236.—Metallic Framing for Ships and other Navigable Vessels.—B. J. La Mothe, of New York City :

I claim a series of metal tubes forming the ribs of ships and other vessels, passing between the longitudinal tubes forming the keel and keelson, substantially as specified.

I also claim forming the knees uniting the decks to the sides of the vessel, by bending the tubes forming or extending from the deck or rib tubes, as set forth.

And I claim the combination of ribs formed of pipes, with longitudinal pipes passing between each other and clamped together, substantially as set forth.

37,237.—Lamp Wick.—Frederick McKee, Pittsburgh, Pa. :

I claim as a new article of manufacture a lamp wick made out of pulp, and felted or hardened together, instead of being woven, plaited or twisted, as herein set forth, and this I claim whether the pulp be incased in an outer protection or not, as described.

37,238.—Railroad Car Brake.—D. Myers, South Bend, Ind. :

I claim, first, Applying the rubbers to the wheels of a train of cars by means of suitable rods or chains and levers, and a sleeve surrounding one of the axes of the tender or one of the axes of the first car, and when a pulley, K, with its flanges, each edge having a spiral groove, is formed on the said sleeve as set forth, for the purpose specified.

Second, I claim the levers, R and R', their pulleys, s, s, and chains, t and r, the whole being arranged and operating in conjunction with the brake levers, I and I', substantially as and for the purpose herein set forth.

37,239.—Railway Lamp.—T. J. Newland, Utica, N. Y. :
I claim the tubes, B B', or their equivalents, constructed and operating substantially as described.

37,240.—Lock.—J. M. Perkins, Cleveland, Ohio :
I claim, first, The guard plates, D D', and stops, F I, constructed, arranged and operating as and for the purpose described.

Second, I claim the guard, K, the stop, K', and the wards, a, arranged and operated as and for the purpose specified.

37,241.—Combination Lock.—G. M. Phelps, Williamsburgh, N. Y. :

I claim, first, The key spindle, B, having both a rotary and a longitudinal movement, and provided with a feather, f, in combination with the series of disk tumblers, A A', each having an internal notch, g, and a yielding holder, e, substantially as and for the purpose herein described.

Second, In combination with the series of independent disk tumblers, A A', each having an internal notch or slot, g, and a series of notches, k, around its periphery, with a click, e, applied thereto, and all mounted on a sliding and turning spindle, B, provided with a feather, f, substantially as herein described, the notch or groove, j, in the said spindle and pawl or stop, K, applied thereto, substantially as and for the purpose herein set forth.

Third, In combination with the bolt, C, bolt tumbler, D, and series of disk tumblers, A A', mounted upon, and formed so as to be turned and adjusted by the sliding and turning key spindle, B, substantially as herein described, the collar, L, or its equivalent, whereby the said key spindle, when disengaged from the said disk tumblers, can be engaged with and disengaged from the said bolt tumbler and bolt, substantially as and for the purpose herein set forth.

Fourth, The arrangement of the pawl, P, by which the toothed hubs, q, are secured to the rims, r, of the disk tumblers, with the perforation, Q, and slot, a, in each of the said rims, the hole, R, in the lock case, and the tongue, c, of the bolt tumbler, substantially as and for the purpose herein described.

37,242.—Boot-crimping Machine.—Corydon Pratt, Pratt's Hollow, N. Y. :

I claim, first, The combination and arrangement of mechanism, substantially as described, whereby the jaws, when moved downward or in the opposite direction from which the leather is forced on to the former, are released from pressure on the leather, substantially as represented and described.

Second, The U-shaped expander, provided with double-inclined plains, and acting upon the springs, G G, in the manner substantially as set forth.

37,243.—Umbrella.—T. H. Ray, North Adams, Mass. :
I claim the combination of the closing rod, b, with the spring catch, A, when they are constructed, arranged and fitted to produce the result, substantially as herein described.

37,244.—Churn.—William Robinson, Bellefontaine, Ohio :
I claim, first, Suspending the body, A, of a churn upon a central spindle, c', in the manner and for the purpose substantially as set forth.

Second, In combination with the cylinder, A, and spindle, c', I claim the stationary dasher, E, constructed substantially as and for the purpose set forth.

Third, I claim the cap, e, in combination with the spindle, c', and opening, i, substantially as and for the purpose set forth.

37,245.—Lubricator for Steam Engines.—James Roscoe, Leicester, England :
I claim constructing a lubricator with an air pipe, I, in combination with the other parts, substantially as described and represented.

37,246.—Mode of operating Brakes of Railroad Cars.—A. G. Safford, Boston, Mass. :

I claim the combination of the "equalizer," P, with the pulley, N, and the chains of the windlasses, R K, and the system of brake levers.

Also, the arrangement of the spring drum, S, and its coupling and winding mechanisms (viz.: the teeth, h, i, and the system of one or more springs, k k), with the pulley, N, arranged between the two trucks, and so as to operate substantially in manner as specified.

Also, The combination and arrangement of two or more separate springs, k k, with the spring drum, S, and its rotary head or ratchet, T.

Also, The arrangement and combination of a relieving mechanism (viz.: the windlass, o, with its ratchets, p q, and retaining and impelling pawls, r U, and connections, l m n), with the rotary spring drum, S, and the chain pulley, N, arranged substantially as hereinbefore specified.

Also, The arrangement of the tripping lever, V, with the car body and the relieving mechanism, substantially as specified.

Also, The combination and arrangement of the auxiliary brake levers, K K, with the pulley, N, and the system of levers and rods connecting the brakes of trucks, as described.

37,247.—Reversible Neck Scarf.—A. S. Saroni, New York City :

I claim a reversible scarf, provided with a neck piece made of card board, B, or any other suitable material, coated with hatter's sizing, and provided with an elastic loop or loops, so that the scarf, A, is properly attached to the collar either side out, at the same time presenting the appearance of a carefully-adjusted cravat or neck-tie.

37,248.—Metallic House.—S. J. Seely, Brooklyn, N. Y. :
I claim, first, The foundation sill, a' a', constructed in the manner and for the purpose substantially as described.

Second, I claim constructing the sheet-metal walls, D D', with ribs, e, and plane-faced surfaces, e', substantially as and for the purpose set forth.

Also, I claim the connecting sill, M, constructed in the manner and for the purpose substantially as described.

Fourth, I claim the girders, G, in combination with the walls, D D', substantially as described.

37,249.—Cork.—W. H. Towers, New York City :

I claim the cork with the wire extending through it from top to bottom, the whole constructed and arranged substantially as set forth and for the purpose specified.

37,250.—Operating Ordnance.—Otis Tufts, Boston, Mass. :
I claim the gun carriage with its attached turn-table, in combination with the sliding or recoil carriage on which the table turns, and the training carriage or slide that supports them, substantially as described.

I claim operating a pivot-gun carriage and the gun thereon, substantially in the manner set forth, viz.: by locating the shaft through which the power is transmitted, so that it will be concentric with the train of motion or axis.

I claim the training pin or pivot, i', when formed to admit the passage of a shaft concentrically through it, and combined with the training carriage of the gun.

I claim so arranging and combining a friction-producing clamp with the slide and ways of a gun carriage that it may be operated at one central point, substantially in the manner described, in the place of two separate clamps each requiring its own adjustment, as heretofore employed.

I claim so combining the clamp, s', and the clamp, v, that they are operated by one device in common, substantially in the manner set forth.

37,251.—Cultivator.—W. S. Weir, Jr., Monmouth, Ill. :
I claim, first, The combination and arrangement of the frame, B tongue, A, and wheels, C C, substantially as set forth.

Second, The combination with the posts, B' B', and plow beams, of the loops, a, and draft-adjusting devices, b, b, substantially as set forth.

37,252.—Photographic Plate-holder.—A. B. Wilson, Waterbury, Conn. :

I claim, first, The double funnel and stem, with separate channels, constructed and operating substantially as and for the purpose described.

Second, Securing the negative glass in position in the manner and by the means of a plate-holder, constructed and operating substantially as described.

37,253.—Harvester.—A. L. Darby, of White Creek, N. Y., assignor to himself and J. H. Balch, of Cambridge, N. Y. :

I claim, first, The apparatus for lifting and turning over the finger bar, to wit: the lever, L, and chain, with shafts, S and G, coupled by an universal joint, and operated by bevel wheel gear K and R, with shaft and pinches, when used in combination with the vibrating frame, B, for the purposes set forth in the within specification.

Second, The construction of the cutter guard or finger as described, with the cylindrical opening back of the points of the cutters and forward of the cutter bar, and providing the front part of the guard with cutting edges on the upper ridge and flank edges and lower ridge, or on the upper ridge and flank edges alone, for the purpose specified.

37,254.—Churn.—Thomas T. Ffirth, Camden, N. J., assignor to himself and G. W. Adler :

I claim any suitable number of flutter wheels, E and F, when arranged to revolve in the direction shown, in combination with any convenient number of ribs, H, H', &c., and their concave recesses, the whole being arranged and operating as and for the purpose set forth.

37,255.—Apparatus for Pressing Hats.—J. S. Giles and William Halladay, New York City, and J. A. Rue, Brooklyn, N. Y., assignors to J. S. Giles and William Halladay aforesaid :

I claim the block, d, fitted to slide vertically in combination with the hinged blocks, c e and b, and forming the crown die for pressing flaring or bell-crowned hats or bonnets substantially as specified.

37,256.—Skeleton Skirt.—J. M. Kinney, Columbus, Ohio, assignor to himself and D. D. Winant, Brooklyn, N. Y. :

I claim a skeleton skirt formed of springs radiating from a suitable waist-belt and connected to each other to retain them in a skirt form by elastic or non-elastic cords, tapes or their equivalents, substantially as specified.

37,257.—Divided Vent-bushing for Ordnance to facilitate Unspiking.—B. G. Martin (assignor to Jerome Buck), New York City :

I claim the divided and doweled cylinder, the combination of the said bisected and perforated cylinder and vent-field detachable from the cannon or other fire-arm and from each other for the purpose of bushing any vent-hole whenever needed, and the combination of the bisected and perforated cylinder and wrench detachable from each other as well as from the vent-hole for the purpose of unspiking cannon or other fire-arm and showing the vent-hole all operating as above described.

37,258.—Apparatus for Condensing and Evaporating.—J. J. Miller, (assignor to himself and Ernst Prussing), Chicago, Ill. :

I claim, first, The combination of the closed vessel, A, and alternately concave and convex rotating pans, D and E, with suitable induction and eduction ports, the whole being arranged to operate substantially as and for the purposes set forth.

Second, The combination of the surrounding jacket or coil, J, with the said closed vessel and pans substantially as and for the objects specified.

Third, Securing the pans, D and E, upon the shafts, B, by means of the collar, M, tubes, d, and clamping nut, N, substantially as and for the purposes described.

37,259.—Platform Scale.—Elnathan Sampson, Waterford, N. Y., assignor to the Sampson and Tibbit's Scale Company, Green Island, N. Y. :

I claim the employment or use of bell-crank levers, k l k' l' p q, connected by rods or their equivalents in combination with the oscillating vertical or pendent levers, C C', from which the platform, A, is suspended, all constructed, arranged and operating substantially in the manner and for the purpose herein shown and described.

37,260.—Projectile for Rifled Ordnance.—W. H. Smith, (assignor to himself and R. M. Bassett), Birmingham, Conn. :

I claim the jacket or case, B, constructed and combined with the body, A, or projectile proper by means of resin or other suitable cement in its annular cavity, d, substantially as and for the purpose herein specified.

37,261.—Vest.—David Vogl, London, England, assignor to Simon Guiterman, New York City. Patented in England, Dec. 10, 1861 :

I claim the construction of vests closed in front, without arm-holes and held in position around the person by adjustable bands substantially as described.

37,262.—Feed-bag for Horses or other Animals.—W. B. Wait, Greenwood, Mass., assignor to himself and J. A. Fairbanks, Melrose, Mass. :

I claim the nose-bag as made either with the head cap provided with air-lets, b b b, or with the same and an elastic mouth arranged substantially as specified.

I also claim the nose-bag as made with an elastic hanger or its equivalent, and in other respects in manner and so as to operate substantially as hereinbefore specified.

37,263.—Oil Still.—W. G. Warden and Thomas K. Petty, Pittsburgh, Pa. :

We claim the use in stills, for distilling hydro-carbon oils, of a double trap constructed substantially as herein before described, so connected with the still, z, its worm-pipe or goose-neck, as not to return to the still the heavier vapors or any condensed products of distillation, but so that any unevaporized liquid or solid substance, carried over with the vapor or boiling over from the still through the still-head or goose-neck, shall be arrested before reaching the worm or condenser, and returned to the still or collected in a separate receptacle.

Also, Drawing off the unevaporized matter which is carried over from the still in the process of distillation and thereby preventing it passing into the condenser or receptacle for distilled oil by means of the apparatus, substantially as herein before described.

37,264.—Passenger Ticket.—N. D. Morgan, Mount Pleasant, N. Y. :

I claim the combination of a new and improved form of passenger ticket to be used on railroad cars, steamboats and all other public conveyances, card or slip of paper printed or illustrated or both so that the former shall inclose the latter as with an envelope or wrapper; with an aperture in the side of the ticket through which the inclosed card or slip of paper shall exhibit some conspicuous word or illustration to attract the attention of the passenger holding the same, and also open at the ends so that the inclosed card or slip of paper may be easily removed therefrom and retained by the passengers substantially as herein before set forth.

37,265.—Canal Lock.—S. J. Seely, Brooklyn, N. Y. :

I claim, first, The method, substantially as herein described, of constructing canal locks, whereby metal instead of masonry is used to give the requisite strength to the whole structure.

Second, Sustaining the side walls and bottom or flooring of canal locks by means of corrugated metal or its equivalent substantially as described.

Third, The sustaining the walls of the gate channels by means of corrugated metal or its equivalent substantially as described.

RE-ISSUES.

1,367.—Artificial Leg.—Douglas Bly, Rochester, N. Y. Patented May 17, 1859. Re-issued July 3, 1860 :

I claim, first, Curving or deflecting the jointed extremities of the base, J, so as to bring their axes of motion back of their line of direction, substantially as and for the purposes set forth.

Second, I claim the cord, T, and spring, X, acting upon the parts, D and L, substantially in the manner and for the purpose herein set forth.

Third, I claim the combination of the india-rubber spring, E, with a tendon or cord in such a manner that the required effect is derived from the compression and expansion of the material, and not from its elongations and contractions, substantially as set forth.

Fourth, I claim the axial bolts or transverse axes, B C, as and for the purpose herein set forth.

Fifth, I claim providing the ends of the cords, F, with the enlargements and with the conical socket fastenings, G, to receive the same, substantially as described, in order to apply adjusting screws for the purposes herein specified.

Sixth, I claim the manner of constructing the bearing portions of the knee-joint consisting of the upper and lower bearing blocks, N N, each of which forms a segment of a circle more or less corresponding with the axial bolt, the one being fixed in position and the other adjustable by means of adjusting screws, S S, to admit of adjusting the parts together to prevent looseness or to give the desired amount and regulate the friction, substantially as and for the purpose herein set forth.

1,368.—Lamp Chimney.—W. L. Fish, Newark, N. J. :

I claim the use in connection with oil lamps of ordinary construction and operation, of heating vessels containing a central tube so shaped as to form the chimney of said lamp substantially as herein shown and described, whereby the same lamp may be used for both illuminating and heating purposes or for either.

Second, In oil lamps of ordinary construction and in connection with the heating vessel before referred to, I claim the use of a bulb or its equivalent device for the intermediate support of said vessel by the lamp substantially as herein shown and described.

Third, In combination with the said heating vessel and bulb, when the latter is made of an opaque material, I claim the use of a window or of windows made of a transparent material for the transmission of light through it substantially as and for the purposes set forth.

DESIGN.

1,702.—Design for a Cane-head, Umbrella-handle or Sword-hilt.—J. C. Nobles, Rushford, N. Y.

TO OUR READERS.

RECEIPTS.—When money is paid at the office for subscriptions, a receipt for it will always be given; but when subscribers remit their money by mail, they may consider the arrival of the first paper a *bona fide* acknowledgment of our reception of their funds.

INVARIABLE RULE.—It is an established rule of this office to stop sending the paper when the time for which it was pre-paid has expired.

Models are required to accompany applications for Patents under the new law, the same as formerly, except on design patents when two good drawings are all that is required to accompany the petition, specification and oath, except the Government fee.

PATENT CLAIMS.—Persons desiring the claim of any invention which has been patented within thirty years, can obtain a copy by addressing a note to this office, stating the name of the patentee and date of patent, when known, and inclosing \$1 as fee for copying. We can also furnish a sketch of any patented machine issued since 1853, to accompany the claim, on receipt of \$2. Address **MUNN & CO., Patent Solicitors, No. 37 Park Row, New York.**

NEW PAMPHLETS IN GERMAN.—We have just issued a revised edition of our pamphlet of *Instructions to Inventors*, containing a digest of the fees required under the new Patent Law, &c., printed in the German language, which persons can have gratis upon application at this office. Address **MUNN & CO., No. 37 Park-row, New York.**

Back Numbers and Volumes of the Scientific American

VOLUMES I., II., III., IV., V., (NEW SERIES) COMPLETE (bound or unbound) may be had at this office and from a periodical dealers. Price, bound, \$2 25 per volume, by mail, \$3—which include postage. Price, in sheets, \$1 50. Every mechanic, inventor or artisan in the United States should have a complete set of this publication for reference. Subscribers should not fail to preserve their numbers for binding. Nearly all the numbers of VOL. VI. are out of print and cannot be supplied.

PATENTS FOR SEVENTEEN YEARS.

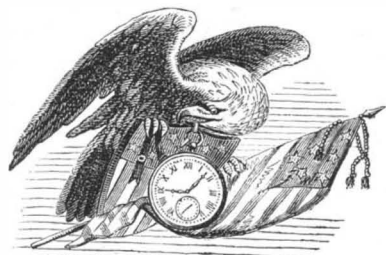

The new Patent Laws, enacted by Congress on the 2d of March, 1861, are now in full force, and prove to be of great benefit to all parties who are concerned in new inventions.

The duration of patents granted under the new act is prolonged to SEVENTEEN years, and the Government fee required on filing an application for a patent is reduced from \$30 down to \$15. Other changes in the fees are also made as follows:—

On filing each Caveat.....	\$10
On filing each application for a Patent, except for a design.....	\$15
On issuing each original Patent.....	\$20
On appeal to Commissioner of Patents.....	\$20
On application for Re-issue.....	\$30
On application for Extension of Patent.....	\$50
On granting the Extension.....	\$50
On filing Disclaimer.....	\$10
On filing application for Design, three and a half years.....	\$10
On filing application for Design, seven years.....	\$15
On filing application for Design, fourteen years.....	\$30

The law abolishes discrimination in fees required of foreigners, excepting reference to such countries as discriminate against citizens of the United States—thus allowing Austrian, French, Belgian, English, Russian, Spanish and all other foreigners except the Canadians, to enjoy all the privileges of our patent system (except in cases of designs) on the above terms.

During the last sixteen years, the business of procuring Patents for new inventions in the United States and all foreign countries has been conducted by Messrs. MUNN & CO., in connection with the publication of the SCIENTIFIC AMERICAN; and as an evidence of the confidence reposed in our Agency by the Inventors throughout the country, we would state that we have acted as agents for more than FIFTEEN THOUSAND Inventors! In fact, the publishers of this paper have become identified with the whole brotherhood of Inventors and Patentees at home and abroad. Thousands of Inventors for whom we have taken out Patents have addressed to us most flattering testimonials for the services we have rendered them, and the wealth which has inured to the Inventors whose Patents were secured through this Office, and afterward illustrated in the SCIENTIFIC AMERICAN, would amount to many millions of dollars! We would state that we never had a more efficient corps of Draughtsmen and Specification Writers than are employed at present in our extensive Offices, and we are prepared to attend to Patent business of all kinds in the quickest time and on the most liberal terms.

The Examination of Inventions.

Persons having conceived an idea which they think may be patentable, are advised to make a sketch or model of their invention, and submit it to us, with a full description, for advice. The points of novelty are carefully examined, and a reply written corresponding with the facts, free of charge. Address MUNN & CO., No. 37 Park-row, New York.

Preliminary Examinations at the Patent Office.

This service we render gratuitously upon examining an invention does not extend to a search at the Patent Office, to see if a like invention has been presented there, but is an opinion based upon what knowledge we may acquire of a similar invention from the records in our Home Office. But for a fee of \$5, accompanied with a model or drawing and description, we have a special search made at the United States Patent Office, and a report setting forth the prospects of obtaining a Patent &c., made up and mailed to the Inventor, with a pamphlet, giving instructions for further proceedings. These preliminary examinations are made through our Branch Office, corner of F and Seventh-streets, Washington, by experienced and competent persons. More than 5,000 such examinations have been made through this office during the past three years. Address MUNN & CO., No. 37 Park-row, N. Y.

How to Make an Application for a Patent.

Every applicant for a Patent must furnish a model of his invention if susceptible of one; or if the invention is a chemical production, he must furnish samples of the ingredients of which his composition consists, for the Patent Office. These should be securely packed, the inventor's name marked on them, and sent, with the government fees by express. The express charge should be prepaid. Small models from a distance can often be sent cheaper by mail. The safest way to remit money is by draft on New York, payable to the order of Munn & Co. Persons who live in remote parts of the country can usually purchase drafts from their merchants on their New York correspondents; but, if not convenient to do so, there is but little risk in sending bank bills by mail, having the letter registered by the postmaster. Address MUNN & Co., No. 37 Park-row, New York.

Foreign Patents.

We are very extensively engaged in the preparation and securing of Patents in the various European countries. For the transaction of this business, we have offices at Nos. 66 Chancery-lane, London; 29 Boulevard St. Martin, Paris; and 26 Rue des Eperonniers, Brussels. We think we can safely say that three-fourths of all the European Patents secured to American citizens are procured through our Agency.

Inventors will do well to bear in mind that the English law does not limit the issue of Patents to Inventors. Any one can take out a Patent there.

Circulars of information concerning the proper course to be pursued in obtaining Patents in foreign countries through our Agency, the requirements of different Patent Offices, &c., may be had gratis upon application at our principal office, No. 37 Park-row, New York, or either of our Branch Offices.

Rejected Applications.

We are prepared to undertake the investigation and prosecution of rejected cases, on reasonable terms. The close proximity of our Washington Agency to the Patent Office affords us rare opportunities for the examination and comparison of references, models, drawings, docu-

ments, &c. Our success in the prosecution of rejected cases has been very great. The principal portion of our charge is generally left dependent upon the final result.

All persons having rejected cases which they desire to have prosecuted are invited to correspond with us on the subject, giving a brief story of the case, inclosing the official letters, &c.

Assignments of Patents.

The assignment of Patents, and agreements between Patentees and manufacturers, carefully prepared and placed upon the records at the Patent Office. Address MUNN & CO., at the Scientific American Patent Agency, No. 37 Park-row, New York.

It would require many columns to detail all the ways in which the Inventor or Patentee may be served at our offices. We cordially invite all who have anything to do with Patent property or inventions to call at our extensive offices, No. 37 Park-row, New York, where any questions regarding the rights of Patentees, will be cheerfully answered.

Communications and remittances by mail, and models by express (prepaid), should be addressed to MUNN & CO., No. 37 Park-row, New York.

Caveats.

Persons desiring to file a Caveat can have the papers prepared in the shortest time by sending a sketch and description of the invention. The government fee for a Caveat, under the new law, is \$10. A pamphlet of advice regarding applications for Patents and Caveats, in English and German, furnished gratis on application by mail. Address MUNN & CO., No. 37 Park-row, New York.



J. H. P. of N. Y.—We have received your note and inclosure, and thank you for your complimentary reference to the SCIENTIFIC AMERICAN. As regards the frictional gearing for your purpose we think it an excellent feature; there are however, some machines such as yours driven through the same agency; of such is Seth Borden's, made in Newark, N. J.; he does not use grooved wheels, however. We cannot tell you the size necessary as there is no work on that subject published. They will not vary greatly from the toothed wheels; they will require to be protected from grease, so that their surfaces will remain dry and bright. It would be necessary, obviously, to know the construction of your valve and the resistance which has to be overcome by the drivers. Experiment will demonstrate better than any other rule which sizes are most desirable. The best packing in our opinion for small stuffing-boxes is an elastic gasket; that is, one having a center of india-rubber, wound outwardly with cotton wick; this clings to the rod and does not require much compression. We do not know the variety you speak of. The "Practical Draughtsman" is the best work you can get for learning to draw. Farrell & Son, Fulton Street, N. Y., are the publishers. Good drawing instruments can be had of any of the philosophical instrument dealers at a very much less price than the one mentioned by you.

O. D. M., of N. Y.—The silk from the ordinary milkweed is not adapted to the making of paper, as a substitute for rags. The fiber is too short and has but little tenacity.

T. C., of Conn.—The steamboat *Daniel Drew* has made 23 miles per hour for seven consecutive hours. The *City of Buffalo* has made 23½ and 24 miles per hour for short distances on Lake Erie. Our ocean steamers have made as high as eighteen miles per hour on occasions; these however, are very rare. They do very well to average 12 miles per hour.

M. T. & Co., of C. E.—You state that you intend to construct an air chamber around your boiler furnace to admit cold air to it at a lower level than you take off the hot air to warm your factory, but that the hot-air pipe will have to dip lower down than the inlet cold-air pipe; and you inquire if it will have sufficient draft. We think it will operate if you make your inlet cold-air pipe smaller than the exit hot-air pipe, so as to relieve the inlet pipe from back pressure.

E. C. M., of —It is possible to cast cannon or a body of metal of any shape by the method you mention, but whether they would be good for anything is a question which would have to be determined by experiment.

H. T. W., of Ohio.—To obtain the silver from the clippings of sensitive photographic paper, first burn them, then collect their ashes, place them in a crucible with some borax, niter or carbonate of potash, and subject the crucible for about two hours to a bright red heat. The silver will then be found in the form of a metallic button at the bottom of the crucible.

Money Received

At the Scientific American Office on account of Patent Office business, from Wednesday, December 24, to Wednesday, December 31, 1862:—

F. M. C., of N. Y., \$20; F. S. B., of Iowa, \$20; S. H., of Ind., \$20; M. H. F., of N. Y., \$20; C. & M., of N. Y., \$120; A. J. E., of N. Y., \$20; W. T. M., of Ill., \$20; H. H. E., of Conn., \$20; S. H., of Ind., \$20; B. T. B., of N. Y., \$45; T. P., of N. Y., \$20; N. A., of Conn., \$20; J. P. D., of Iowa, \$20; N. F., of N. Y., \$45; G. B. M., of Pa., \$45; J. C. C., of Mass., \$20; P. B., of N. Y., \$15; C. W. C., of Pa., \$20; T. C. V., of N. Y., \$20; H. B. F., of N. Y., \$25; D. I. S., of N. Y., \$25; L. S., of N. Y., \$15; M. & B., of Ill., \$30; B. & H., of N. Y., \$15; W. J. S., of N. J., \$40; V. & P., of Mass., \$15; J. F. R., of Pa., \$25; C. B. R., of Pa., \$10; W. F. Q., of Del., \$25; G. M. H., of Ill., \$25; D. M., of Ind., \$10; P. J. C., of Conn., \$25; P. A. C., of Mass., \$25; D. C. G., of Pa., \$15; H. E. P., of Conn., \$25; B. F. C., of Mass., \$15; P. & G. K., of Mass., \$10; H. B., of N. J., \$30; T. H. C., of N. H., \$15; J. D. H., of Pa., \$10; G. W. R., of Ill., \$12; S. C. H., of Mass., \$50; J. R. S., of Va., \$25; S. & B., of N. Y., \$75; A. T., of Wis., \$15; P. M. G. Co., of Conn., \$60; J. R. S., of Pa., \$15; J. A., of N. Y., \$25; J. E., of Conn., \$15; J. D. B., of Vt., \$28; C. St. J., of Mass., \$27; A. Le B., of Paris, \$100; R. E., of Ill., \$15; B. F. A., of Iowa, \$20; C. N. B., of Pa., \$25; G. Van N., of Mass., \$30; J. H., of

Pa., \$25; T. S. D., of N. J., \$315; L. O. C., of Pa., \$50; H. L. C., of N. Y., \$25; F. W. G., of N. Y., \$15; G. S., of N. Y., \$25; T. W. B., of N. J., \$25; R. W., of N. Y., \$25; J. R. D., of Wis., \$15.

Persons having remitted money to this office will please to examine the above list to see that their initials appear in it, and if they have not received an acknowledgment by mail, and their initials are not to be found in this list, they will please notify us immediately, and inform us the amount, and how it was sent, whether by mail or express.

Specifications and drawings and models belonging to parties with the following initials have been forwarded to the Patent Office from December 24, to Wednesday, December 31, 1862:—

H. B. F., of N. Y.; D. I. S., of N. Y.; L. S., of N. Y.; L. A., of Cal.; W. J. S., of N. J.; J. A., of N. Y.; T. W. B., of N. J.; Q. & L., of Del.; P. J. C., of Conn.; P. A. C., of Mass.; T. D. L., of N. H.; J. F. R., of Pa.; H. E. P., of Conn.; H. B., of N. J.; P. & G. K., of Mass.; L. D. C., of Mich.; G. M. H., of Ill.; T. J. H., of N. Y.; G. S., of N. Y.; R. W., of N. Y.; G. W. R., of Ill.; J. D. H., of Pa.; F. W. G., of N. Y.; S. C. H., of Mass. (2 cases); J. A., of N. Y.; C. St. J., of Mass.; H. L. C., of N. Y.; J. R. S., of Va.; L. O. C., of Pa. (2 cases.)

RATES OF ADVERTISING.

Twenty-five Cents per line for each and every insertion, payable in advance. To enable all to understand how to compute the amount they must send in when they wish advertisements inserted, we will explain that ten words average one line. Engravings will not be admitted into our advertising columns; and, as heretofore, the publishers reserve to themselves the right to reject any advertisement they may deem objectionable.

NOW IS THE TIME TO SUBSCRIBE FOR THE BEST

paper for the times! Moore's *Rural New Yorker*, the Leading and most Popular Farm and Fireside Journal in America, will enter upon its Fourteenth Year and Volume in January, 1863. In all the essentials of a first-class Agricultural, Horticultural, Literary and Family Newspaper, combined, the *Rural* has long been pronounced, by both Press and People, the best of its class, and the immense circulation it continues to maintain throughout the Loyal States, Canada, &c., proves that the War for the Union has not diminished its standing or popularity. Our aim will be in the future, as it ever has been in the past, to make it superior in all respects, and unquestionably the most useful home journal published in America! Always Loyal, Practical and Progressive, the *Rural New Yorker* has long been the favorite of Agricultural and Family Weekly—largely read and ardently admired in both Town and Country. Its ample pages comprise Departments devoted to, or which treat ably and fully upon Agriculture, Architecture, Education, Literature, Horticulture, Rural Economy, Arts and Science, General News, with various minor Departments, and including numerous Illustrations, Tales, Sketches, Music, Poetry, Enigmas, &c.—rendering the paper instructive and entertaining to the various members of the Family Circle.

The War News, Markets, &c., receive special attention; the *Rural New Yorker* containing Reports of the principal Grain, Provision, Cattle, Wool and Fruit Markets in the country. Remember that the *Rural New Yorker* is published Weekly in one of the very best cultivated sections of America, and that its Editors, Contributors and Correspondents strive to promote the Pecuniary Interest and Home Welfare of its tens of thousands of readers.

Its Western Corresponding Editor, Chas. D. Bragdon, Esq., whose "Western Editorial Notes," have attracted much attention and been widely copied during the past year, will hereafter devote still more time and thought for the benefit of the *Rural New Yorker* and its readers.

Style, Form, Terms, &c.—Volume XIV, for 1863, will maintain the enviable reputation the *Rural New Yorker* has acquired for both Contents and Appearance. It will be published in Superior Style—with New Type, good white Paper, and many fine Illustrations. Its Form will continue the same as now—Double Quarto—with an Index, Title-page, &c., at close of year, complete for binding.

Terms, always in advance—\$2 a year; 3 copies for \$5; 6 for \$10; 10 for \$15—with a free copy for every club of six or more. Now is the Time to Subscribe and form Clubs. Efficient Local Agents wanted in all places reached by the United States and Canada mails, to whom we offer handsome Premiums. Specimen numbers, premium lists, &c., sent free to all disposed to benefit their neighbors and community by introducing the paper to more general notice and support. Address D. D. T. Moore, Rochester, N. Y.

ENCYCLOPEDIA OF CHEMISTRY, THEORETICAL and Practical, in its application to the Arts, Metallurgy, Mineralogy, Geology, Medicine, and Pharmacy. By James C. Booth, as assisted by Campbell Morfit. Fifth edition, 8vo., \$5.

FACTORY AND CHEMISTRY APPLIED TO THE MANUFACTURE OF SOAP AND CANDLES; being a thorough exposition, in all their minutiae, of the Principles and Practice of the Trade, based upon the most recent Discoveries in Science and Art. By Campbell Morfit. A new and improved edition, with 260 engravings, 8vo., cloth, \$6.

A MANUAL OF ELECTRO-METALLURGY, WITH THE APPLICATION of the art to Manufacturing Purposes. By James Napier. Illustrated, 12mo., cloth, \$1 25. The above or any of my books sent by mail free of postage. HENRY CAREY BAIRD, Publisher of Practical Books, 406 Walnut street, Philadelphia, Pa.

LICENSE TO MANUFACTURE—FISHER'S IMPROVED Wrought-iron Mower, for one or all of the United States. This machine is light, strong and durable. Cutting apparatus hinged to the frame can be folded for transportation in half a minute. The operator with one foot can raise the cutters over obstructions, thus leaving both hands free to manage his team. Thirteen hundred of the above machines have been sold, and they give general satisfaction. Also Fisher's One-horse Iron Mower, weight 350 pounds, draft 80 pounds. It works well. Parties who wish to manufacture or purchase territory may address HENRY FISHER, Alliance, Ohio.

WANTED.—A PARTNER WITH CASH CAPITAL TO introduce a valuable machine, for which Letters Patent have been obtained. Address R. O. LOWRY, Saratoga Springs, N. Y.

THE AMERICAN SHARPSHOOTER.—ILLUSTRATING practical use of Telescope as a sight for rifle, artillery, &c., demonstrating how to sight a gun, how to ascertain fall of ball for all distances, how to get elevation without change of sight, how to measure distances by the Telescope, defining rules how to strike an object at every shot; including other useful information for the gunner. Price, single copy, fifty cents, on receipt of which, sent by mail free of postage. All communications and remittances to undersigned promptly attended to. DANIEL WOOD, Author and Publisher, Rochester, N. Y.

PARTIES DESIROUS OF ENGAGING IN THE MANUFACTURE of a first-class Mower or Reaper and Mower combined; made wholly of iron and steel, with double driving wheels, hinged finger bar, and folding cutting apparatus, will find them in the successful and popular machines, "Cayuga Chief" and "Cayuga Chief, Jr." Address C. WHEELER, JR., Poplar Ridge, Cayuga county, N. Y.

\$60 A MONTH! WE WANT AGENTS AT \$60 A month, expenses paid, to sell our Everlasting Pencils, Oriental Burners, and thirteen other new, useful and curious articles. Fifteen circulars sent free. Address SHAW & CLARK, Biddeford, Maine.

\$75 A MONTH! I WANT TO HIRE AGENTS IN every county a \$75 a month, expenses paid, to sell my new cheap Family Sewing Machines. Address S. MADISON, Alfred, Maine.

WANTED.—AN EXPERIENCED DRAUGHTSMAN, from 20 to 25 years of age; one having a practical acquaintance with Printing, Pattern-making or Machinery preferred.

ARTIFICIAL LIMBS BY E. D. HUDSON, M. D., CLINTON Hall, upstairs, Astor Place, New York. SOLDIERS PROVIDED WITHOUT COST, by commission of the Surgeon General of the United States Army.

FOR SALE.—RIGHTS TO BUILD AND USE OLIVER'S Patent Machine for Manufacturing Gun Stocks. Complete detail drawings furnished. Patented July 1, 1862. Address H. W. OLIVER, New Haven, Conn.

JACQUARD MACHINES, WITH APPURTENANCES manufactured and put up. Looms for narrow goods, from silk ribbon to cotton tulle, built to order on the most approved principles.

THE NEW YORK OBSERVER IS A RELIGIOUS AND SECULAR NEWSPAPER, PUBLISHED on a double sheet, so as to be easily separated into two distinct papers.

In Religion it is free from sectarianism, and gives a full, fair and impartial report every week of all matters of general interest in all the denominations. In Politics it is entirely free from party relations or affinities, discussing great principles with freedom and candor, and giving the fullest and latest intelligence of all the movements of the day.

The N. Y. Observer is the most complete family newspaper in the world. In the variety of its Departments, in the fulness of its information, in the extent of its Correspondence, in the number of minds enlisted in its Editorial and other columns, in the amount of money expended in procuring materials to enrich and adorn its pages, in the healthful, religious, conservative, genial tone that pervades the paper.

The proprietors of the New York Observer offer the following valuable premiums for new subscribers. In all cases the money (\$2 50 for each subscriber) must be paid in advance.

TO MINISTERS AND OTHERS. The Annals of the American Pulpit, by Rev. William B. Sprague, D. D., are comprised in seven large octavo volumes, viz., Congregational, 2 vols.; Presbyterian, 2 vols.; Methodist, 1 vol.; Episcopal, 1 vol.; Baptist, 1 vol. They contain the biography of more than a thousand ministers, and a history of each denomination, with a statement of its doctrinal views, making a complete library of religious biography and history.

TO FARMERS AND OTHERS. The Farmers' Encyclopedia, Farm Record, and any five other books on the list—or the entire list, except the Encyclopedia and Record. For five new subscribers, with payment in advance, we will send the Farmer's Encyclopedia and Farm Record, or any other five books in the list.

FOR SALE.—THE WHOLE OR PART OF A MACHINE Shop, Foundry attached. A very desirable location for a man of enterprise. Address GROVE BROTHERS, Newark, N. J., or CHAS. H. SMITH, 135 North 3d Street, Philadelphia.

AGRICULTURAL INSTRUMENT MAKERS.—SEND lowest cash price lists to J. WYATT REID, Plantation Supply Store, 11 Old Slip, New York.

RARE AND BEAUTIFUL FLOWER SEEDS FREE TO all who join the "RURAL KEYSTONE CLUB." 25 cts. in \$1 clear saving on all subscriptions to newspapers and periodicals. For full particulars send stamps to P. SUTTON, Ransom, Pa.

HADLEY'S PATENT TAP GUIDE.—FOR SALE STATE, County and Shop Rights, or the whole patent. See engraving and description in the SCIENTIFIC AMERICAN of Dec. 20, Vol. VII., No. 25. WM. S. HADLEY, Norwalk, Huron Co., Ohio.

THE UNDERSIGNED WISHES TO MAKE ARRANGEMENTS with parties having capital to enable him to manufacture, on an extensive scale, "Brady & Noble's Self-Loading Gun" (illustrated in No. 6, Vol. VI., of the SCIENTIFIC AMERICAN (new series). Its range is 1,000 yards. For facility of loading and rapidity of firing it is equalled by no gun in use. Address FREEMAN BRADY, Jr., Washington, Pa.

FOR SALE.—SIXTEEN CONSECUTIVE VOLUMES OF the SCIENTIFIC AMERICAN, beginning with Vol. VI., old series. In first-rate order. Address Box 23, Carlisle, Pa.

DANIEL'S PLANING MACHINES, COMBINING RECENT and very valuable improvements, with first-class workmanship, making the full rated width of the machine, with the dead weight of the bed. Decided by competent judges as the best Daniel's Planer yet made. Parties about purchasing should address the only manufacturer, RICHARDSON, MERIAM & CO., Worcester, Mass.

AGENTS WANTED!—MALE OR FEMALE!—AGENTS wanted in every county and town in the United States to sell on commission (by sample) the best and cheapest Sewing Machine in the world. Agents make from \$30 to \$50 per month. For terms and further information please enclose a letter stamp and address to N. SHANNON & CO., Manchester, N. H.

MESSIEURS LES INVENTEURS.—AVIS IMPORTANT. Les Inventeurs non familiers avec la langue Anglaise e qui preferent nous communiquer leurs inventions en Frangais, peuvent adresser dans leur langue les descriptions de leurs inventions, avec une description concise pour notre examen. Nous vous communiquerons ensuite nos observations en Frangais. MUNN & CO., Scientific American Office No 37 Park row, New York.

GREAT INTERNATIONAL AGRICULTURAL EXHIBITION at Hamburg, Germany, of 1863. To Inventors and Manufacturers of Agricultural Implements and Machinery. This exhibition, which is to open on June 1, 1863, will be the first opportunity offered to American Inventors and Manufacturers to bring to the immediate notice of the people of Northern and Central Europe, the great improvements of this country in Agricultural Implements and Machinery, and such other important inventions pertaining to domestic economy and other various occupations of industry.

WANTED A PARTNER WITH SOME CAPITAL TO join in an iron ship-building establishment and machine shop, in a most favorable location. Address "Engineer," Letter Box 885, Philadelphia P. O., Pa.

INCORUSTATION IN BOILERS.—A POSITIVE REMEDY. Winans' Anti-Incorustation Powder, seven years in successful use, will give it preference over any other unknown mixtures lately put in the market. References, George Shield, Miles Greenwood and others in Cincinnati; American Bank Note Company, &c., New York; and over 1,000 more throughout the country. Circulars on application to H. N. WINANS, Box 6, P. O., New York.

ATTENTION, MASONS AND MECHANICS.—AGENTS wanted. I will send (as sample) on the receipt of \$1 a handsome Gold Masonic Ring, or Gold Masonic Chain, or Gold Chain attached, or New Style Scarf Pin, or Plated Vest Chain, or a Fine Gold Pen and Pencil, or Engraved Locket or Bracelet, or Neck Chain, or a beautiful set of Jewelry, together with my wholesale circular. C. P. GIRTON, Manufacturing Jeweler, 208 Broadway.

REYNOLDS' PATENT CONCENTRAL PRESSURE Water Wheel. For illustrated circulars and information concerning this superior wheel, address with particulars, TALLCOT & UNDERHILL, Oswego, N. Y., or D. TALLCOT, agent, 482 Broadway, New York.

VALUABLE DOCK PROPERTY FOR SALE.—THE subscriber offers for sale a valuable plot of ground on Newtown Creek, near Penny Bridge, in the City of Brooklyn. The property is very desirably situated in the Seventeenth Ward, Meeker avenue, a great thoroughfare, forming the southern boundary of the premises. A valuable dock privilege of over 400 feet on Newtown Creek, renders the property very desirable for large manufacturing or storage purposes.

OIL! OIL! OIL! For Railroads, Steamers, and for Machinery and Burning. PEASE'S Improved Engine and Signal Oil, indorsed and recommended by the highest authority in the United States. This Oil possesses qualities vitally essential for lubricating and burning, and found in no other oil. It is offered to the public upon the most reliable, thorough and practical test. Our most skillful engineers and machinists pronounce it superior to all other oils, and the only oil that is in all cases reliable and will not gum.

TO PHOTOGRAPHERS.—IMPROVED PHOTOGRAPHIC Camera, Patented March 25, 1862, by A. B. WILSON (Patentee of the Wheeler and Wilson Sewing Machine), adapted to all photographic work; such as Landscapes, Stereoscopic Views, Carte Visites, Ambrotypes, &c. Can be used by amateurs and others from printed directions. Send for a circular. Address A. B. WILSON, Waterbury, Conn.

DAMPER REGULATORS.—GUARANTEED TO EFFECT a great saving in fuel, and give the most perfect regularity of power. For sale by the subscribers, who have established their exclusive right to manufacture damper regulators, using diaphragms or flexible vessels of any kind. Orders promptly attended to, or information given, by addressing CLARK'S PATENT STEAM AND FIRE REGULATOR COMPANY, 229 Broadway, N. Y.

FURNITURE WHOLESALE AND RETAIL.—DEGRAAF and Taylor still continue the Wholesale and Retail Furniture and Bedding business at No. 87 Bowery, New York, and have now on hand the largest surplus stock ever before offered in this city, which they have determined to sell for very low prices. For sale by J. C. CARY, No. 2 Astor House, New York.

SOLID EMERY VULCANITE.—WE ARE NOW MANUFACTURING wheels of this remarkable substance for cutting, grinding and polishing metals, that will outwear hundreds of the kind commonly used, and will do a much greater amount of work in the same time, and more efficiently. All interested can see them in operation at our warehouse, or circulars describing them will be furnished by mail.

FULTON'S COMPOUND, FOR CLEANSING STEAM boilers of scale.—This article is powerful to remove scale, and will not injure the boiler. Western agents, WALWORTH, HUBBARD & CO., Chicago, Ill. Sole proprietor, E. H. ASHCROFT, No. 82 Sundry street, Boston, Mass.

GUILD & GARRISON'S CELEBRATED STEAM Pumps.—Adapted to every variety of pumping. The principal styles are the Direct Action Excelsior Steam Pump, the Improved Balance Wheel Pump, Duplex Vacuum and Steam Pumps, and the Water Propeller, an entirely new invention for pumping large quantities at a light lift. For sale at Nos. 55 and 57 First street, Williamsburgh, and No. 74 Beekman street, New York.

WOODWORTH PLANING MACHINES, MORTISING, Tenoning and Sash machines, Scroll Saws, Saw Mandrels, Circular Saws, and other wood working machines. For sale by CHAS. H. SMITH, 135 North Third street, Philadelphia, Pa.

ALCOTT'S CONCENTRIC LATHES.—FOR BROOM Hoe and Rake Handles, Chair Rounds, &c.—Price, \$25; and all other kinds of Wood-working Machinery, for sale by S. C. HILLS, No. 12 Platt-street, New York.

WOODWORTH PLANING MACHINES, MORTISING, Tenoning and Sash machines, Scroll Saws, Saw Mandrels, Circular Saws, and other wood working machines. For sale by CHAS. H. SMITH, 135 North Third street, Philadelphia, Pa.

ALCOTT'S CONCENTRIC LATHES.—FOR BROOM Hoe and Rake Handles, Chair Rounds, &c.—Price, \$25; and all other kinds of Wood-working Machinery, for sale by S. C. HILLS, No. 12 Platt-street, New York.

AGENTS WANTED!—MALE OR FEMALE!—AGENTS wanted in every county and town in the United States to sell on commission (by sample) the best and cheapest Sewing Machine in the world. Agents make from \$30 to \$50 per month. For terms and further information please enclose a letter stamp and address to N. SHANNON & CO., Manchester, N. H.

MESSIEURS LES INVENTEURS.—AVIS IMPORTANT. Les Inventeurs non familiers avec la langue Anglaise e qui preferent nous communiquer leurs inventions en Frangais, peuvent adresser dans leur langue les descriptions de leurs inventions, avec une description concise pour notre examen. Nous vous communiquerons ensuite nos observations en Frangais. MUNN & CO., Scientific American Office No 37 Park row, New York.

IMPORTANT TO INVENTORS.

MESSRS. MUNN & CO., PROPRIETORS OF THE SCIENTIFIC AMERICAN, continue to solicit patents in the United States and all foreign countries, on the most reasonable terms.



Consultation may be had with the firm between NINE and FOUR o'clock, daily, at their PRINCIPAL OFFICE, No. 37 PARK ROW, NEW YORK. We have also established a BRANCH OFFICE in the CITY OF WASHINGTON, on the CORNER OF F AND SEVENTH STREETS, opposite the United States Patent Office.

They are very extensively engaged in the preparation and securing of Patents in the various European countries. For the transaction of this business they have Offices at Nos. 66 Chancery Lane, London 29 Boulevard, St. Martin, Paris, and 26 Rue des Eperonniers, Brussels. We think we may safely say that three-fourths of all the European Patents secured to American citizens are procured through our Agency.

The annexed letters from former Commissioners of Patents we commend to the perusal of all persons interested in obtaining Patents:— MESSRS. MUNN & CO.—I take pleasure in stating that while I held the office of Commissioner of Patents MORE THAN ONE-FOURTH OF ALL THE BUSINESS OF THE OFFICE came through your hands.

MESSRS. MUNN & CO.—It affords me much pleasure to be testified to the able and efficient manner in which you discharged your duties as Solicitors of Patents while I had the honor of holding the office of Commissioner. Your business was very large, and you sustained, I do not doubt, the public confidence thus indicated.

MESSRS. MUNN & CO.—Gentlemen: It gives me much pleasure to say that, during the time of my holding the office of Commissioner of Patents, a very large proportion of the business of inventors before the Patent Office was transacted through your Agency, and that I have ever found you faithful and devoted to the interests of your clients, as well as eminently qualified to perform the duties of Patent Attorneys with skill and accuracy.

MESSRS. MUNN & CO.—I afford me much pleasure to be testified to the able and efficient manner in which you discharged your duties as Solicitors of Patents while I had the honor of holding the office of Commissioner. Your business was very large, and you sustained, I do not doubt, the public confidence thus indicated.

MESSRS. MUNN & CO.—Gentlemen: It gives me much pleasure to say that, during the time of my holding the office of Commissioner of Patents, a very large proportion of the business of inventors before the Patent Office was transacted through your Agency, and that I have ever found you faithful and devoted to the interests of your clients, as well as eminently qualified to perform the duties of Patent Attorneys with skill and accuracy.

MESSRS. MUNN & CO.—Gentlemen: It gives me much pleasure to say that, during the time of my holding the office of Commissioner of Patents, a very large proportion of the business of inventors before the Patent Office was transacted through your Agency, and that I have ever found you faithful and devoted to the interests of your clients, as well as eminently qualified to perform the duties of Patent Attorneys with skill and accuracy.

PUMPS! PUMPS!! PUMPS!!!—CARY'S IMPROVED Rotary Force Pump, unrivaled for pumping hot or cold liquids Manufactured and sold by CARY & BRAINERD, Brockport, N. Y. Also, sold by J. C. CARY, No. 2 Astor House, New York.

BAIRD'S PATENT PREPARATION FOR THE PROTECTION of Steam Boilers from Incrustation.—It does not injure the metals; is a great saving of fuel; does not foam, and works equally well in salt and fresh water. For sale by JAMES F. LEVIN, No. 23 Central Wharf, Boston, Mass. New York depot, COLES & CO., No. 91 West street.

MACHINE BELTING, STEAM PACKING, ENGINE HOSE.—The superiority of these articles, manufactured of vulcanized rubber, is established. Every belt will be warranted superior to leather, at one-third less price. The Steam Packing is made in every variety, and warranted to stand 300 degs. of heat. The Hose never needs oiling, and is warranted to stand any required pressure; together with all varieties of rubber adapted to mechanical purposes. Directions, prices, &c., can be obtained by mail or otherwise at our warehouse. NEW YORK BELTING AND PACKING COMPANY.

IRON PLANERS, LATHES, FOUR SPINDLE DRILLS Milling Machines, and other Machinists' Tools, of superior quality on hand and finishing, and for sale low. For description and prices address NEW HAVEN MANUFACTURING COMPANY, New Haven, Conn.

PORTABLE STEAM ENGINES.—COMBINING THE maximum of efficiency, durability and economy with the minimum of weight and price. They are widely and favorably known, more than 200 being in use. All warranted satisfactory or no sale. A large stock on hand ready for immediate application. Descriptive circulars sent on application. Address J. C. HOADLEY, Lawrence, Mass.

Zur Beachtung für deutsche Erfinder. Die Unterzeichneten haben eine Anstalt, die Erfindern das Verhalten angibt, um sich ihre Patente zu sichern, herauszugeben, und verabfolgend solche gratis an zu liefern. Erfinder, welche nicht mit der englischen Sprache bekannt sind, können ihre Mittheilungen in der deutschen Sprache machen. Stücken von Erfindungen mit kurzen, deutlich geschriebenen Beschreibungen belieben man zu adressiren an Munn & Co., 37 Park Row, New-York.

Die Patent-Gesetze der Vereinigten Staaten, nebst den Regeln und der Geschäftsvorfahrung der Patent-Office und Anweisungen für den Erfinder, um sich Patente zu sichern, in den Ver. St. sowohl als in Europa. Ferner Anstalten aus den Patent-Gesetzen fremder Länder und darauf bezügliche Nachrichten; ebenfalls nützliche Anstalten für Erfinder und solche, welche Patentrecht möchten. Preis 20 Cts., per Kopf 25 Cts.

Improved Patent Cart.

The inconvenience and delay which those interested experience in loading timber, calls for some remedy, and we herewith illustrate an apparatus which is designed to facilitate this business. It consists, as will be seen, of a cart having a movable tail-board, A, to which are attached the iron bars, B. These bars are fastened to the tail-board at one end; the other extremity slides through an iron box, C, which is secured to the body of the cart. There are also several small holes at regular intervals, into which the pin,

charcoal, and half a dozen stone-hammers were taken out; and the eastern end of the mass shows plainly that a portion has been broken off.

The average dimensions are—length, 15 feet 7 inches; width, 3 feet 7 inches (it is full 5 feet in one place); thickness, 1 foot 6 inches; giving 87.135 cubic feet. All these measurements are rather under than over the average. One measurement gave 120 cubic feet, but we consider the first figures the most reliable. They would give the weight of the mass as 23 tons, 1,924 lbs. There is but little vein rock

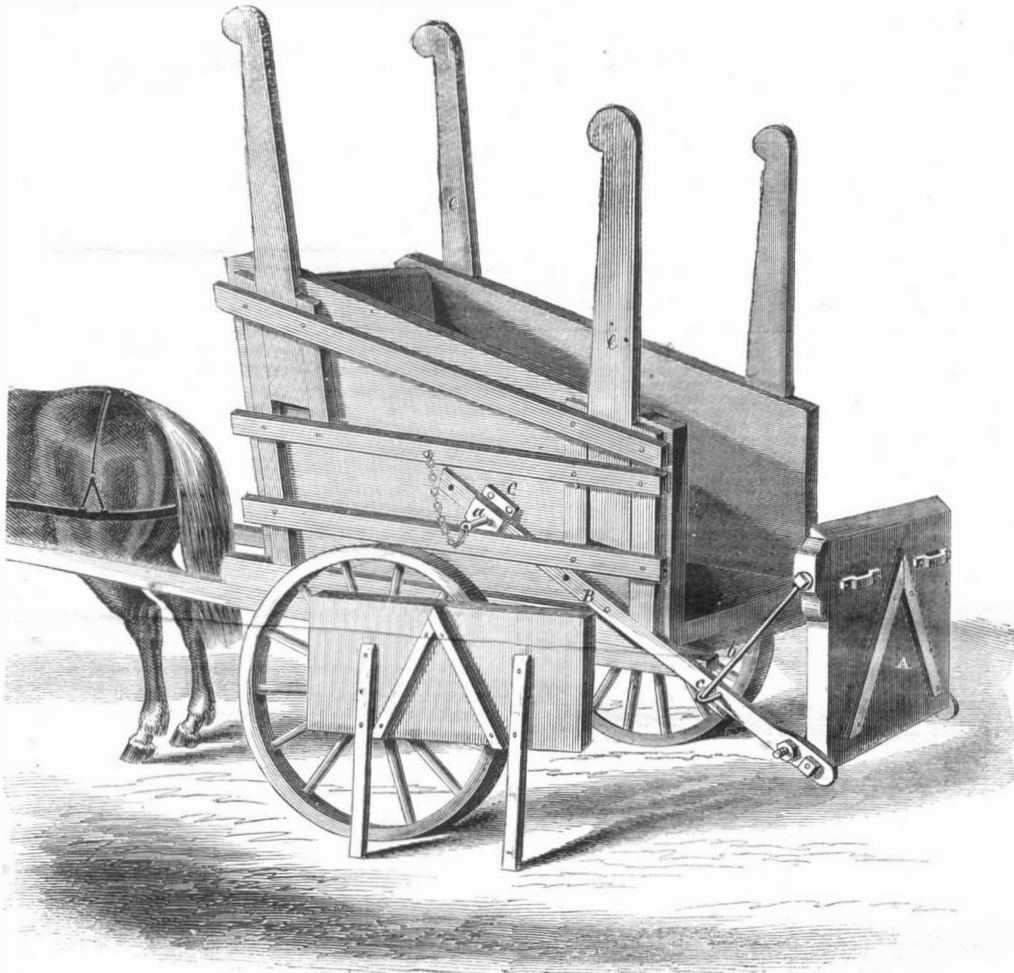

GRAMBO'S PATENT CART.

a, is inserted through the box and bar, as shown very clearly in our engraving. Attached to the tail-board are the hooks, *b*, one on either side, these catch in the staples, *c*, provided for their reception in the bars, B. The operation of this apparatus will be very readily understood. When it is desired to secure the boards which may have been previously placed in the cart, the adjustable tail-board is drawn out to suit the required length, and the pin is then inserted in its place; the holes can be made at various distances so as to accommodate the different lengths to which timber is cut. By looking at the upper end of the tail-board on the cart, the reader will see two light iron cleats; these are provided for the reception of the tail-board seen resting against the cart wheel; this latter appurtenance, in connection with the uprights, *c*, permit a load as great as can be drawn by any ordinary pair of horses to be quickly and easily secured against the possibility of its working loose. This invention is a very useful one and can be made as strong as it is required to be.

A patent has been applied for through the Scientific American Patent Agency, and the patent is ordered to issue. Harrison Grambo, of No. 416 North Second street, Philadelphia, is the inventor, from whom further information can be obtained.

Large Masses of Copper.

The two great masses of copper recently discovered in the Mesnard district, Michigan, have excited considerable attention, as evidences of the inexhaustible and wonderfully productive nature of the Lake Superior copper region. Little of the first mass was above the surface when discovered, and that little was so covered by moss and small underbrush as to hardly attract attention. Upon being uncovered and the soil removed from around its sides, traces of Indian workings were found—pieces of

attached to the block. Two pieces, one from each end, have been cut off the mass. Where it is cut through, the mass is pure copper, and very compact. The two pieces have been taken to the smelting works, and weighed $5\frac{1}{2}$ tons. The second mass found was still larger, measuring 40 feet in length and 4 in breadth. It weighed about 50 tons.

SPRAGUE'S PATENT LEVER BUCKLE.

If there is any one class of the community who are under greater obligations to our inventors than the

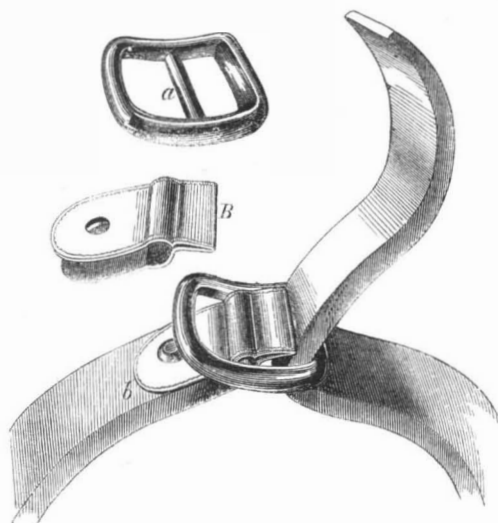

skaters are, we have yet to learn that fact. We illustrate herewith a new lever buckle, which is certainly a great addition to the skater's repertoire. Our engraving explains itself very fully. The frame, A, (which can be made of any metal desired, usually

brass or cast-iron, however,) has a shaft, *a*, through its center, over which is sprung the lever or tongue, B; this tongue is then riveted to the strap, *b*, at one end. The other features of the invention are not peculiar, except in the absence of holes or other devices of the kind for maintaining a rigid position of the skate or other fixture that it is intended to confine with the strap. The advantages of such a fastening as this are self-evident: it can be quickly and easily applied, the leather is not cut by holes which soon destroy its strength, and the piece confined by it can be held with any required degree of tightness. Such qualities as these should make this buckle extremely popular with skaters, and it is equally well adapted for other purposes.

The patent for this invention was procured through the Scientific American Patent Agency, May 27, 1862. Charles Goodyear, Jr., is owner of the patent, and has the buckles for sale at 345 Broadway, New York City.

NEW PROSPECTUS OF THE Scientific American.

FOR 1863

VOLUME VIII.—NEW SERIES.

The publishers of this popular and cheap illustrated newspaper beg to announce that on the third day of January, 1863, a new volume commenced. The journal will be issued in the same form and size as heretofore, and it will be the aim of the publishers to render the contents of the paper more attractive and useful than ever before.

The SCIENTIFIC AMERICAN has been published weekly for eighteen years, and is the most popular and largely-circulated journal of its kind in the world.

Owing to the enormous increase in the price of printing paper the publishers are, to their regret, compelled to increase the subscription price of the SCIENTIFIC AMERICAN to \$3 per annum for single subscribers.

As heretofore, every number of the SCIENTIFIC AMERICAN will be profusely illustrated with first-class original engravings of new inventions and scientific discoveries, all of which are prepared expressly for its columns.

The SCIENTIFIC AMERICAN is devoted to the interests of Popular Science, the Mechanic Arts, Manufactures, Inventions, Agriculture, Commerce, and the Industrial pursuits generally, and is valuable and instructive not only in the Workshop and Manufactory, but also in the Household, the Library and the Reading Room.

The SCIENTIFIC AMERICAN has the reputation, at home and abroad, of being the best weekly journal devoted to mechanical and industrial pursuits now published, and the proprietors are determined to keep up the reputation they have earned during the eighteen years they have been connected with its publication.

To the Inventor!

The SCIENTIFIC AMERICAN is indispensable to every inventor, as it not only contains illustrated descriptions of nearly all the best inventions as they come, but each number contains an Official List of the Claims of all the Patents issued from the United States Patent Office during the week previous; thus giving a correct history of the progress of inventions in this country. We are also receiving, every week, the best scientific journals of Great Britain, France and Germany; thus placing in our possession all that is transpiring in mechanical science and art in those old countries. We shall continue to transfer to our columns copious extracts from those journals of whatever we may deem of interest to our readers.

To the Mechanic and Manufacturer!

No person engaged in any of the mechanical pursuits should think of doing without the SCIENTIFIC AMERICAN. It costs but six cents per week; every number contains from six to ten engravings of new machines and inventions which cannot be found in any other publication. It is an established rule of the publishers to insert none but original engravings, and those of the first class in the art, drawn and engraved by experienced artists, under their own supervision, expressly for this paper.

TERMS.

To mail subscribers:—Three Dollars a Year, or One Dollar for four months. One Dollar and Fifty Cents pay for one complete volume of 416 pages; two volumes comprise one year. A new volume commenced on the third of January, 1863.

CLUB RATES.

Five Copies, for Six Months.....	\$6
Ten Copies, for Six Months.....	12
Ten Copies, for Twelve Months.....	23
Fifteen Copies, for Twelve Months.....	34
Twenty Copies, for Twelve Months.....	40

For all clubs of Twenty and over the yearly subscription is only \$2 00. Names can be sent in at different times and from different Post-offices. Specimen copies will be sent gratis to any part of the country.

Western and Canadian money, or Post-office stamps, taken at par for subscriptions. Canadian subscribers will please to remit 25 cents extra on each year's subscription to pre-pay postage.

MUNN & CO., Publishers,
Park Row, New York.

FROM THE STEAM PRESS OF JOHN A. GRAY